

# Taymor®

*Raising the Bar for 75 Years*

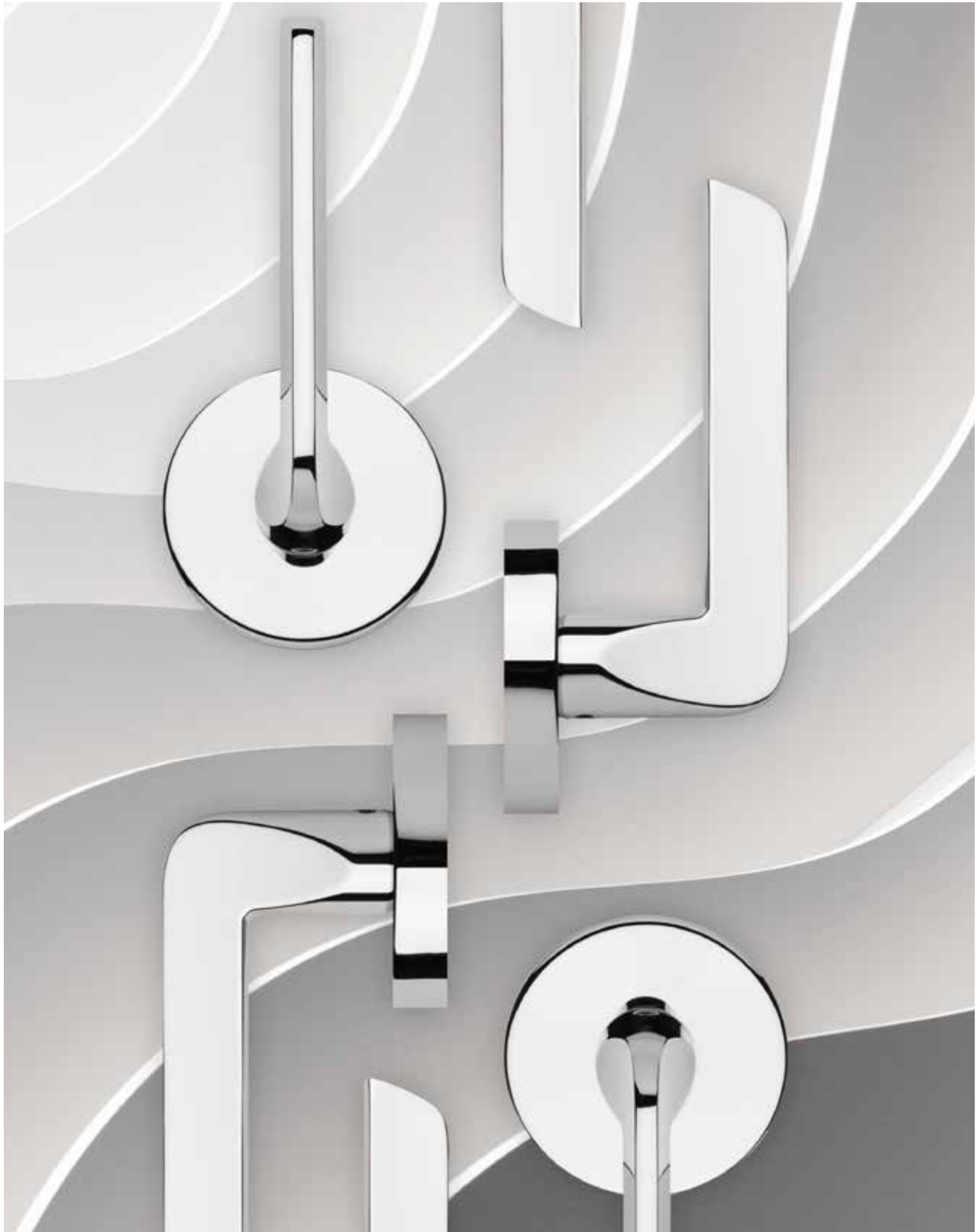

**2023  
HARDWARE CATALOGUE**

CANADA SUMMER 2023

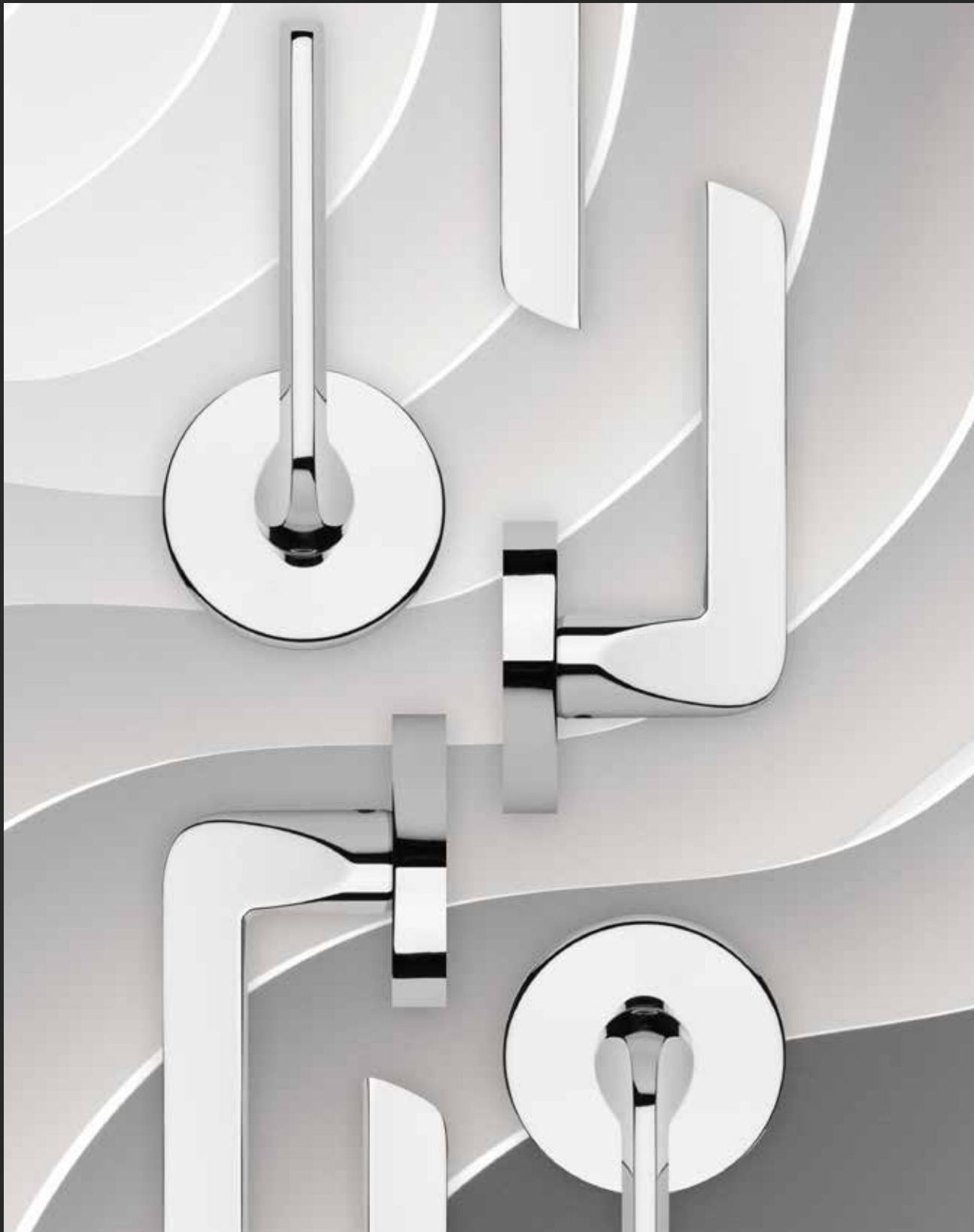

2023

HARDWARE CATALOGUE

Design that *inspires*.  
Quality that *endures*.  
Impressions that *last*.

At Taymor, we believe

*exceptional finishing touches*  
have the power to elevate—  
bringing spaces, projects, and  
partnerships to new heights.

# Contents

## Door Hardware

<b>The Premier Line</b> _____	<b>48</b>	<b>Interior Hardware</b> _____	<b>90</b>
Locksets _____	50	Hinges _____	90
Rose Kits _____	56	Door/Floor/Wall Stops _____	92
Deadbolts _____	57	Closet & Cabinet Hardware _____	93
Mortise Locks _____	58	Handrail Brackets _____	95
Interconnected Locks _____	60	Door Security _____	96
Handlesets _____	63	Pull & Push Plates _____	97
<b>Professional Select</b> _____	<b>65-67</b>	<b>Commercial Locks &amp; Hardware</b> _____	<b>99</b>
<b>Professional Series®</b> _____	<b>69</b>	Locksets & Deadbolts _____	100
Locksets _____	70	Mortise Locks _____	104
Sliding Door Locks _____	71	Door Closers _____	105
Digital Deadbolts _____	72	Exit Hardware, Trims & Accessories _____	108
Deadbolts _____	75	<b>Parts &amp; Services</b> _____	<b>112</b>
Lockset/Deadbolt Combo Pack _____	75	Pro/Key Program _____	112
Handlesets _____	76	Escutcheons _____	114
<b>Builders Series</b> _____	<b>78</b>	Keying Services & Accessories _____	115
<b>Epic Lock Series®</b> _____	<b>79</b>	Residential/Commercial Parts _____	116
<b>Pro/Key Program</b> _____	<b>80</b>	<b>Handleset Customization</b> _____	<b>120</b>
<b>Exterior Hardware</b> _____	<b>83</b>	<b>Fire Rating</b> _____	<b>121</b>
House Numbers _____	84	<b>Finish Guides</b> _____	<b>121</b>
House Number Plaques _____	86		
Door Knockers _____	87		
Door Viewers _____	88		
Kick Plates _____	89		

# Bath Hardware

<b>Bath Hardware</b> _____	<b>124</b>
The Collections _____	126
<b>Bathsets Quick Find</b> _____	<b>149</b>
<b>Bath Accents</b> _____	<b>150</b>
Towel Shelves _____	151
Caddies & Baskets _____	151
Bath & Shower Accessories _____	151
Shower Curtains & Hooks _____	152
Shower Rods & Flanges _____	152
<b>Bath Safety</b> _____	<b>154</b>

# Reference

<b>Testimonials</b> _____	<b>42</b>
<b>Warranty Information</b> _____	<b>156</b>
<b>Terms &amp; Conditions</b> _____	<b>157</b>
<b>Door Hardware Index</b> _____	<b>158</b>
<b>Bath Hardware Index</b> _____	<b>160</b>





## *Design & Innovation*

The pursuit of great design is central to everything we do at Taymor. It inspires our in-house product designers, guides our close collaboration with leading interior designers, and helps us create innovative and exclusive products that contribute to the success of any project.

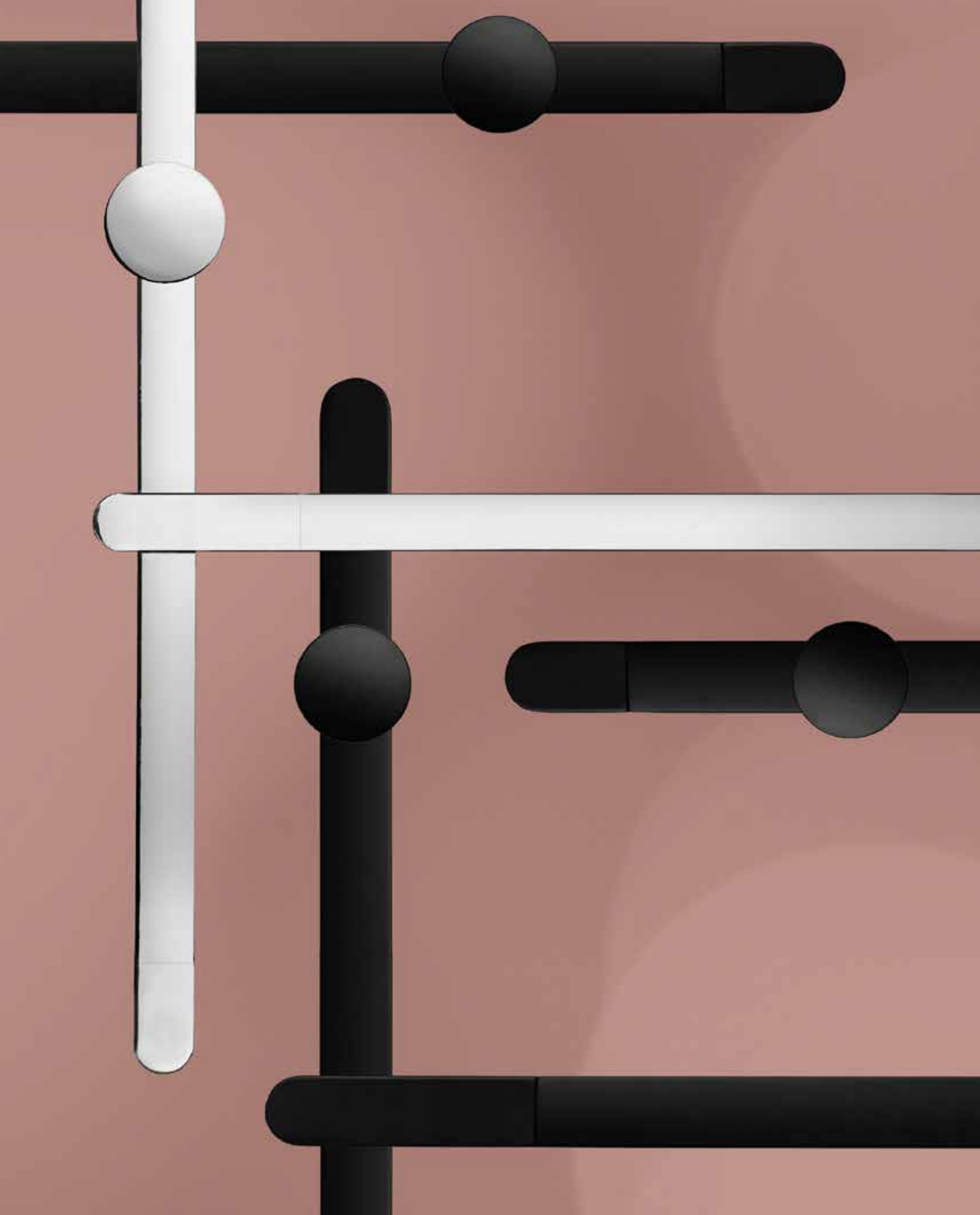



# Raise the *Bar*



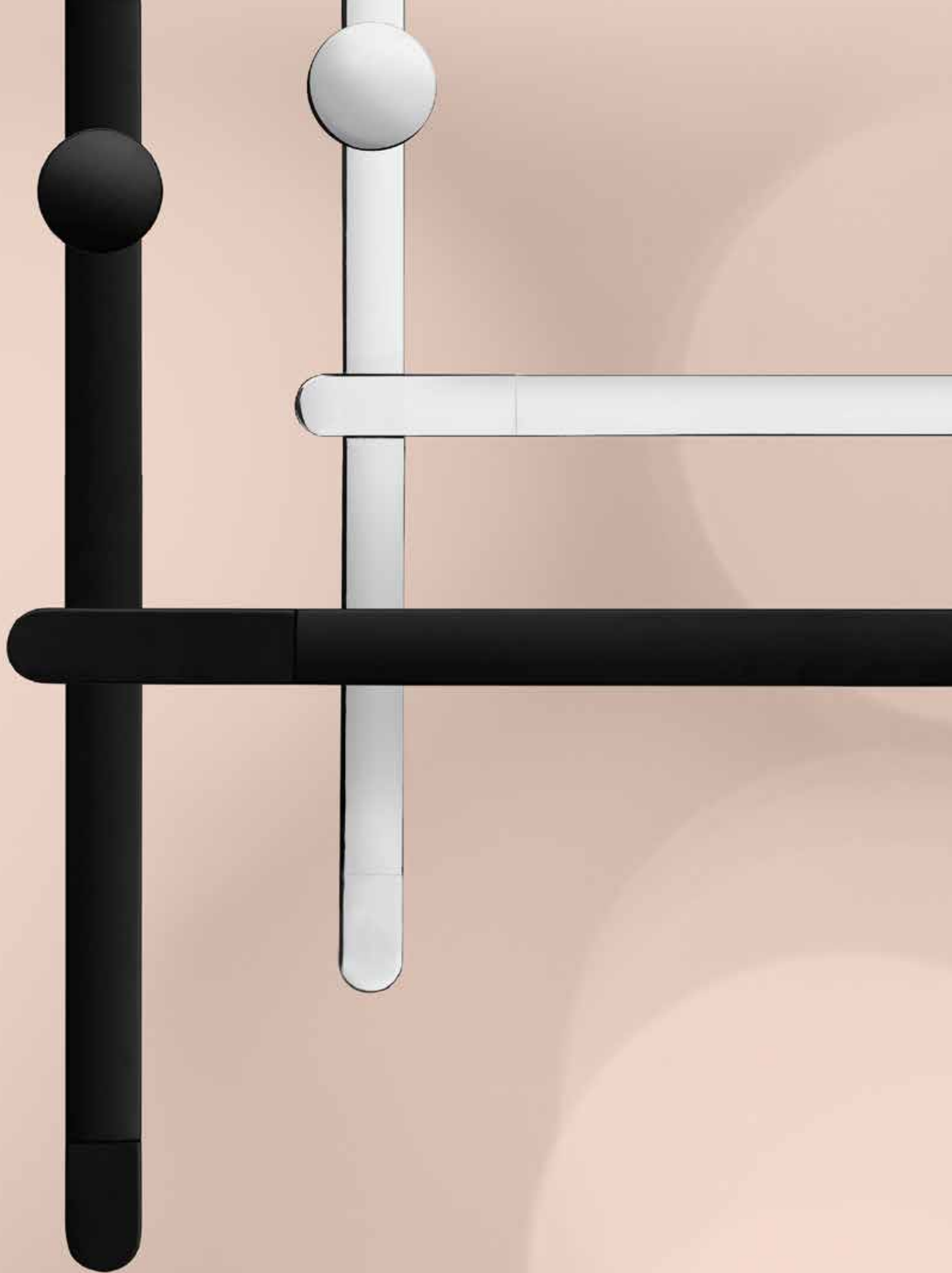

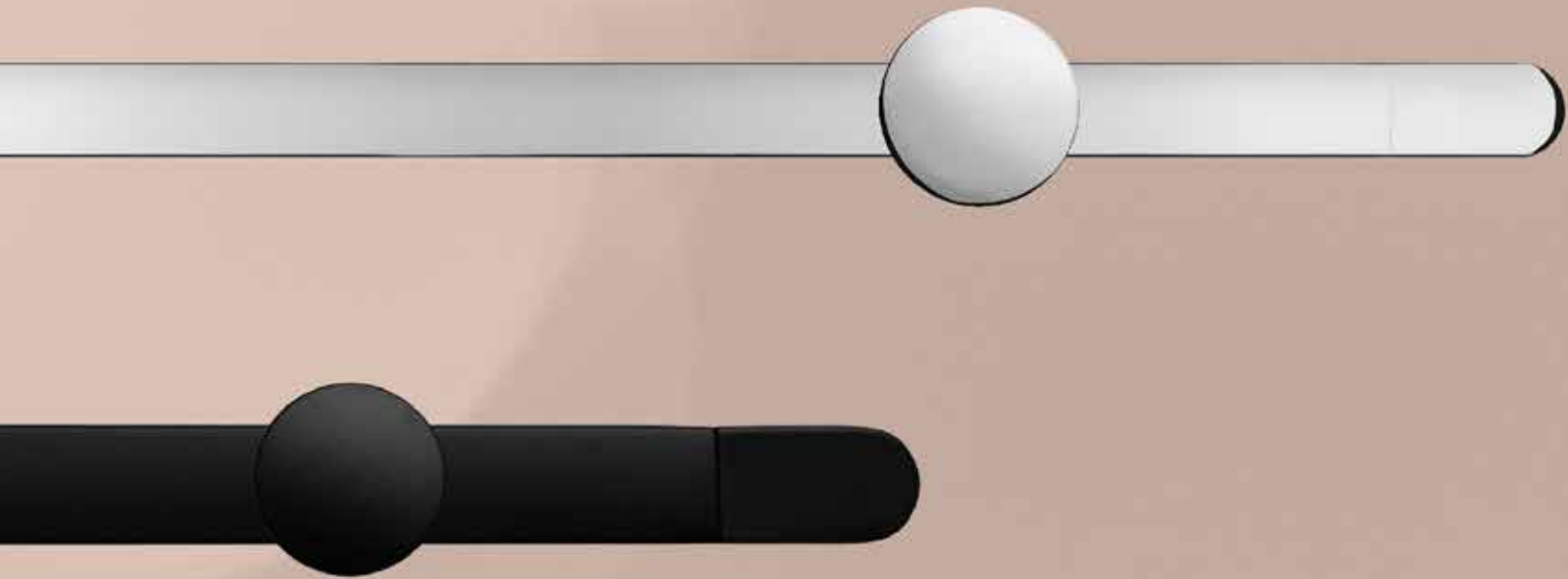

INTRODUCING **Dual Harmony.**  
A SCULPTURAL COLLECTION FROM TAYMOR THAT FEATURES  
DUAL ELEMENTS AND DUAL FINISHES, PERFORMING IN  
SYMPHONY TOGETHER. MOVEABLE HOOKS PUNCTUATE THE  
BARS LIKE NOTES ACROSS A SHEET OF MUSIC. CUSTOMIZABLE,  
INTUITIVE, AND CONTEMPORARY, DUAL HARMONY DELIVERS  
INCREASED FUNCTIONALITY IN A REFINED FORM. BRING  
HARMONY TO THE BATHROOM, WITH A LIFESTYLE SOLUTION  
YOU CAN TAILOR TO YOUR NEEDS.

PAGES  
126–127



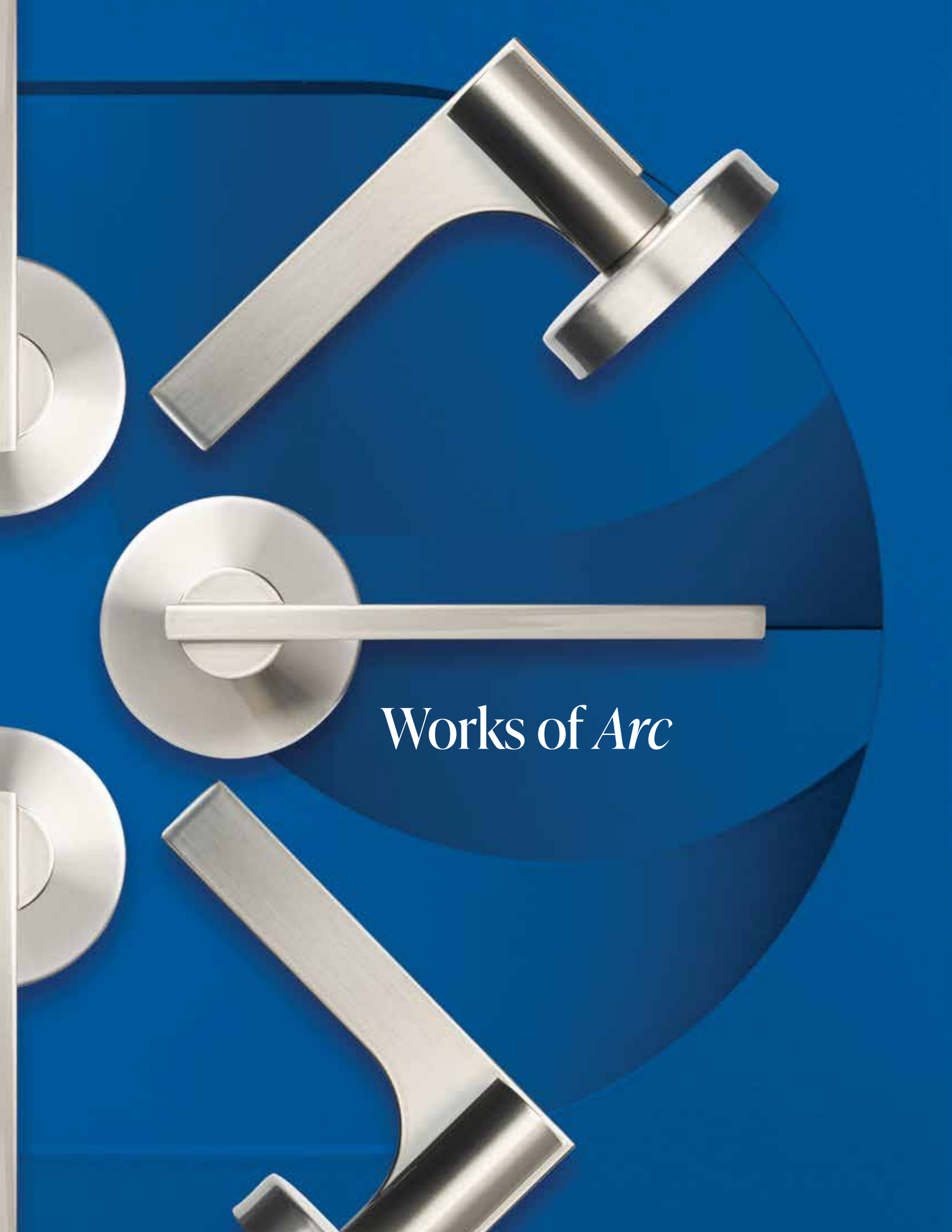

*Works of Arc*





INTRODUCING *Arc Deco*, AN EXCLUSIVE COLLECTION OF COORDINATED DOOR AND BATH HARDWARE THAT EMBRACES SIMPLICITY AND EXPRESSION OF PURE SHAPE. EACH PIECE FEATURES STRONG INTERSECTING LINES THAT TRANSITION TO A DISTINCTIVE ARC, BALANCING STYLISTIC ELEGANCE WITH SCULPTURAL FORM.

PAGES  
51 &  
128–129



# Message from *Vivian Zalkow* CEO

As we reflect on a year of transformational global change and look to the future, being a design-led company has never felt more important. Now more than ever, it's clear the spaces we call home have the power to enrich our lives and elevate our wellbeing—from serving as a source of comfort to being a point of long-lasting pride. At Taymor, thoughtful design that brings spaces to life has been at the heart of our offering for 75 years. I'm proud to say that tradition continues on every page of this catalogue.





# Creating Lasting Impressions *Since 1948*

Family owned since 1948, the same enduring values that motivated founder Jake Zalkowitz continue to inspire our company today. Our passion to raise the creative bar, build partnerships with integrity, and execute service excellence fosters solutions that exceed expectations from first touch to lasting impression.



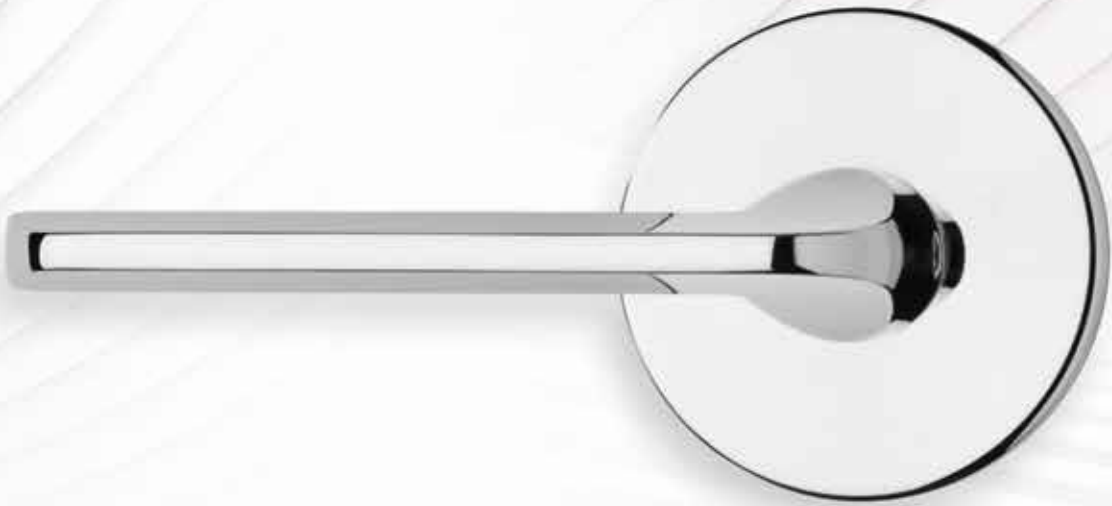

*Fluidity*  
in Design

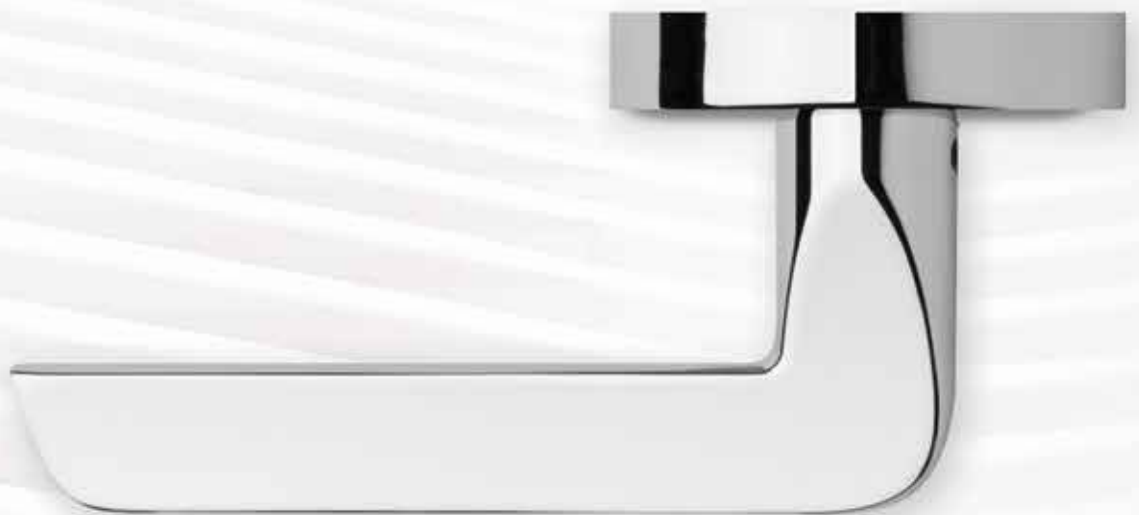
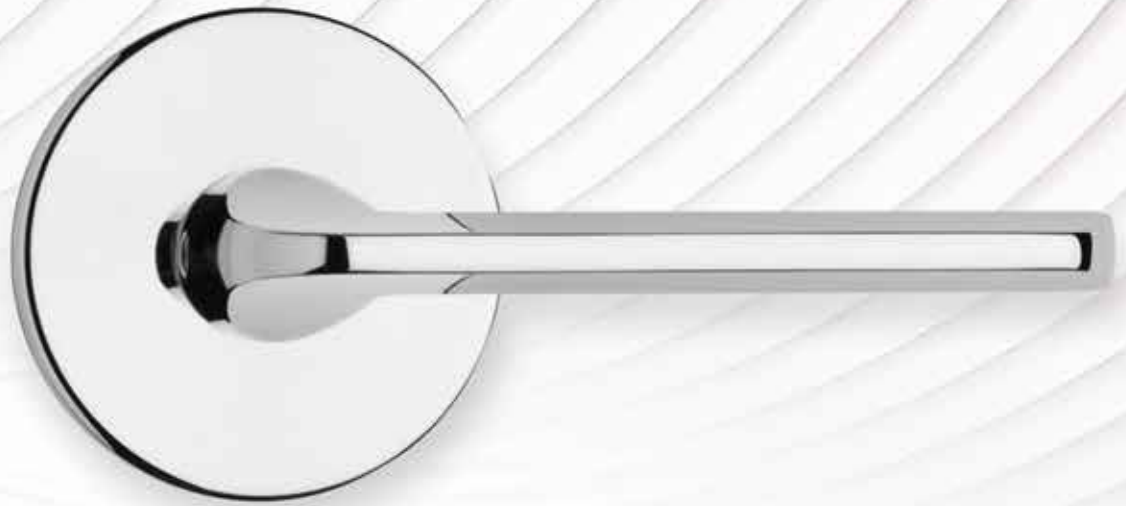

THE **Slip Stream** COLLECTION IS AN EXCLUSIVE LINE OF COORDINATED DOOR AND BATH HARDWARE. WITH A FLUID, DYNAMIC FORM THAT INVITES YOU TO TOUCH, SLIP STREAM'S SOFT ANGLES, GLIDING CONTOURS, AND COORDINATED METAL FINISHES LEND DISTINCTION AND GRACE TO THE REFINED INTERIOR.

PAGES

52 &  
130–131



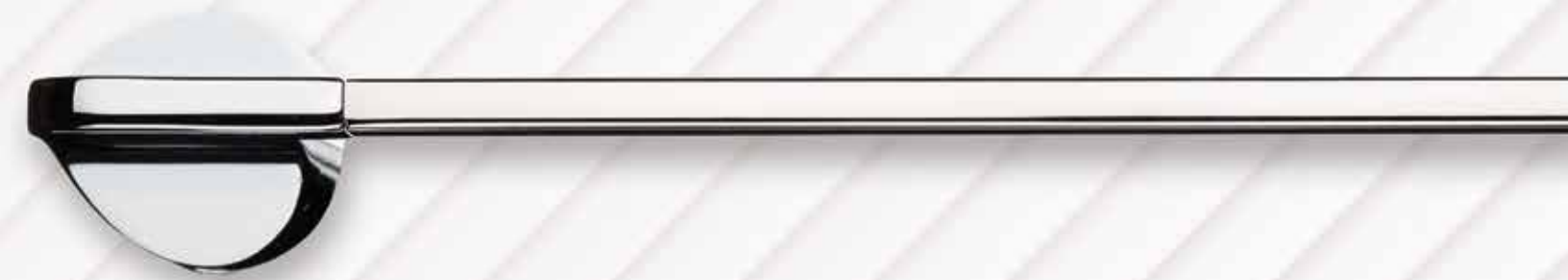





# Service & Experience

We believe in always putting the customer's needs first. It's a principle many companies aspire to but at Taymor it's ingrained deep in our DNA. For 75 years we've been building meaningful and trusted relationships with builders and their teams so we can support their ongoing success.





*Timeless Design*



The background is a warm-toned wooden wall with a post-and-beam architectural style. A vertical wooden post runs down the center, intersected by horizontal wooden beams. Three black metal brackets are mounted on the wall, each consisting of a horizontal bar and a vertical stem with a base. The brackets are positioned on the left side of the wall, with one at the top, one in the middle, and one at the bottom.

THE **1948** COLLECTION BY TAYMOR  
COMMEMORATES OUR FIRST YEAR IN BUSINESS.  
FEATURING COORDINATED INTERIOR LOCKS  
AND BATH ACCESSORIES — AND DEVELOPED IN  
CONSULTATION WITH SOME OF NORTH AMERICA'S  
LEADING INTERIOR DESIGNERS — 1948 IS INSPIRED  
BY NORTH AMERICAN WEST COAST MODERNIST  
POST-AND-BEAM ARCHITECTURAL CONSTRUCTION.  
WITH INTERLOCKING GEOMETRIC FORMS, 1948 PAYS  
HOMAGE TO THE STRENGTH AND CENTURIES-OLD  
INGENUITY OF JAPANESE JOINERY.

PAGES  
**53 &  
132–133**

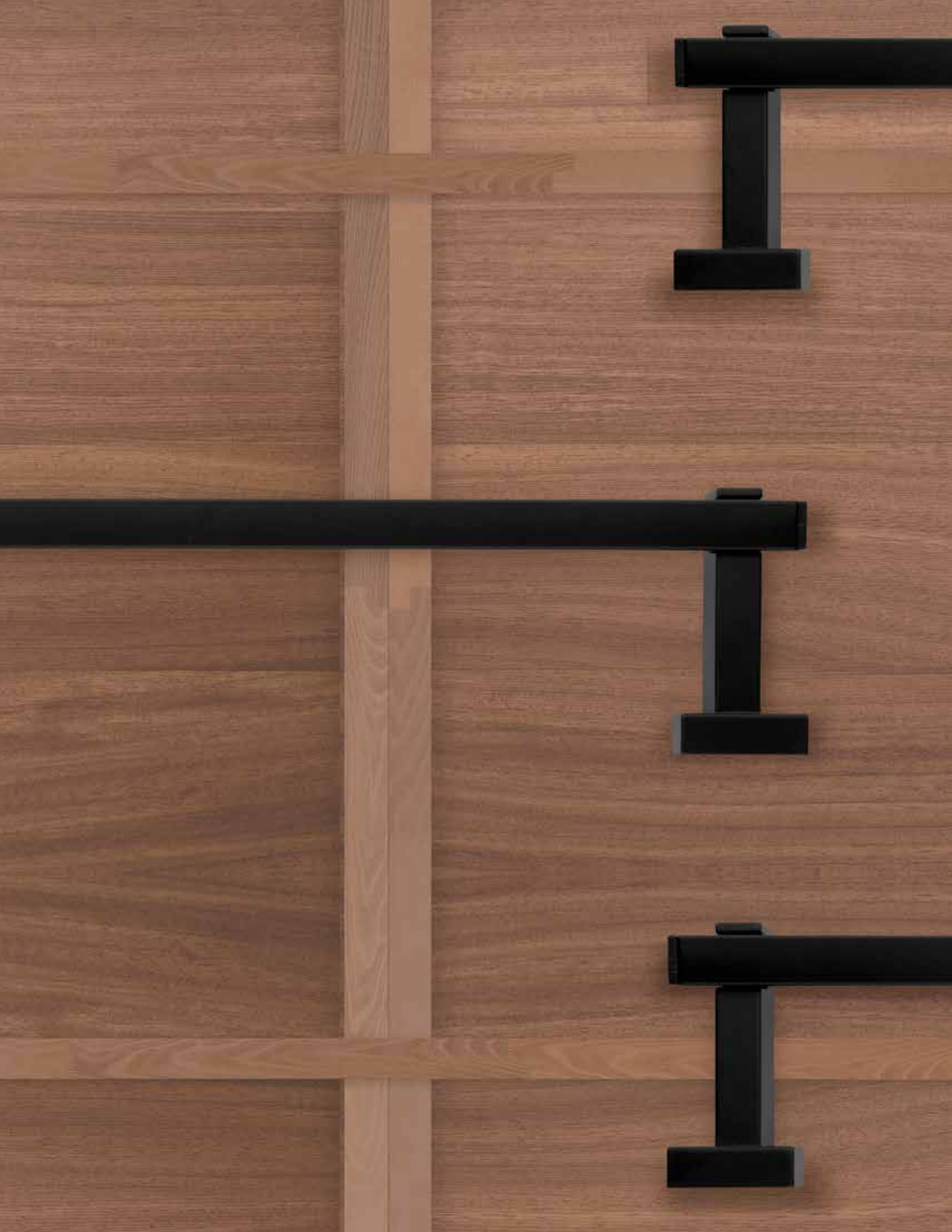

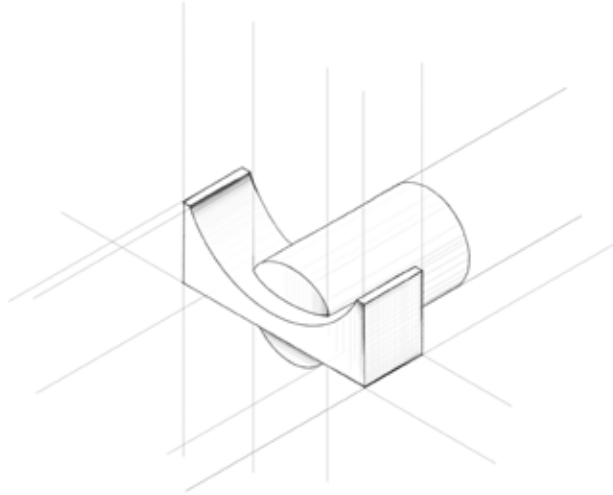

## *Quality & Craft*

We love the craft. That means creating lasting impressions from your very first touch. Our in-house product design teams continually refine and enhance products for durability, ease of install, and performance. The end result is tangible. A level of quality you can feel in your hand.









VEGA LEVER

Square Rose, Satin Nickel

page 54





**BERGEN LEVER**

**Round Rose, Polished Chrome**

**page 55**





**SPELLBOUND**  
**Robe Hook, Polished Chrome**  
**page 142**

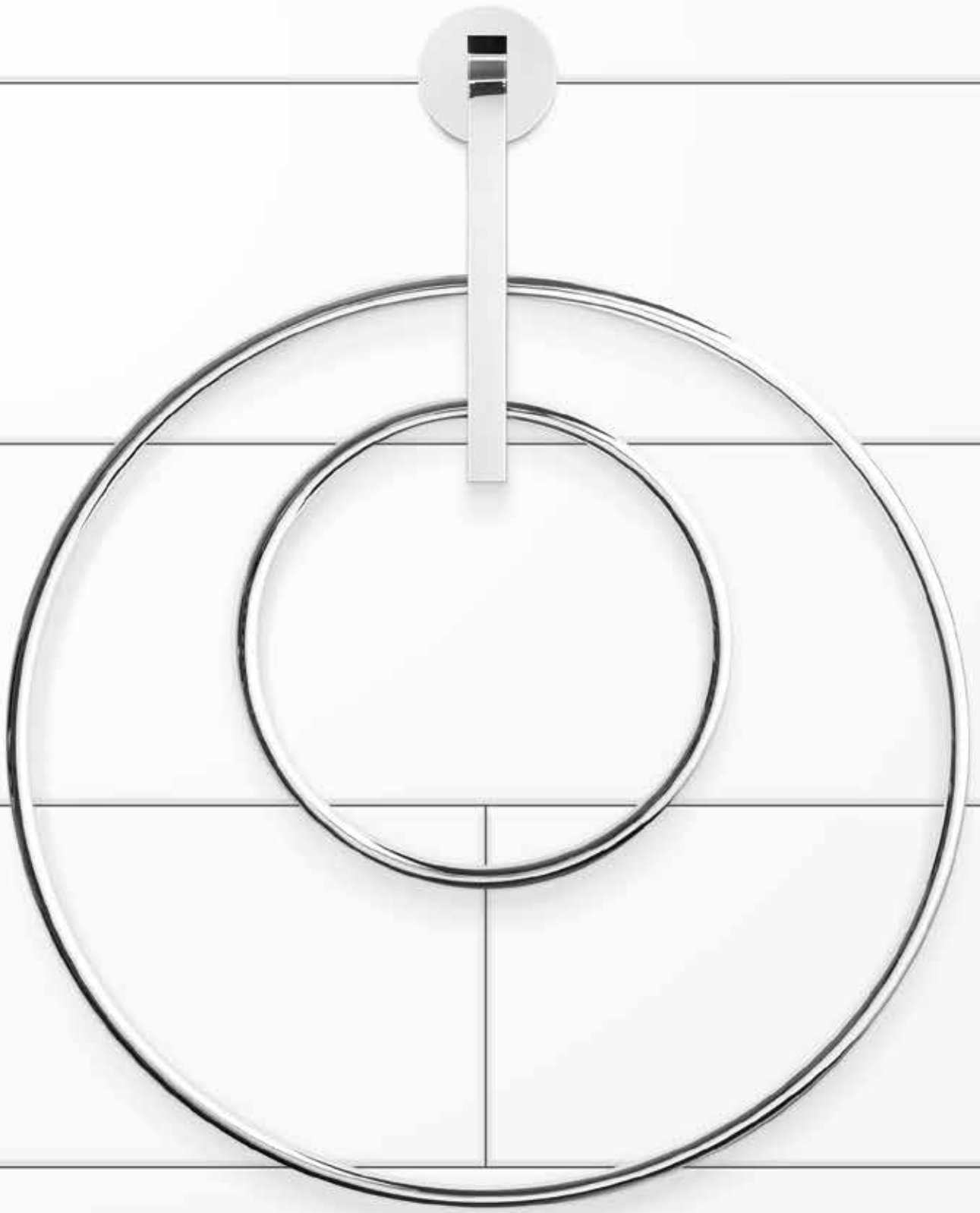



**BITTER SUITE**  
**Double Towel Ring, Polished Chrome**  
**page 135**







**ELECTRA**  
**Vertical Paper Holder, Polished Chrome**  
**page 136**



*“Always there when  
you need them.”*

Working with Taymor, we know that a solution is only a call away. Whether we need new material or have an issue on a project, our Taymor representative is always available.

If there's a problem, Taymor probably knows about it before we do because they're in constant contact with the development site.

Our customers love value, but they're also very discerning. That's why Taymor's quality hardware and affordability make them a perfect extension of our brand.

**ERIC ANDREASEN**  
SENIOR VICE PRESIDENT, SALES & MARKETING  
**ADERA DEVELOPMENT CORPORATION**



**“Trust, reliability, and  
*a fresh approach to design.*”**

RDG's success is built in part on excellent relationships with our suppliers, and it's why we value our long-term partnership with Taymor.

We want our consumers to have a good experience with us. That starts with superior design and function across all of our projects. Taymor helps us by consistently delivering high-quality, affordable hardware solutions.

We've worked exclusively with Taymor for twelve years, so we know what to expect. But Taymor's unique and fresh approach to hardware also gives our interior designers the ability to create new and enhanced looks and feels for our spaces.

**JOHN REMPEL**  
PRESIDENT  
**RDG MANAGEMENT LTD.**



“Great relationship.  
*Great Company.*”

Greystar is the global leader in rental housing. We design under an ethos of serenity, peace, and simplicity, and Taymor products fit the bill perfectly with their clean lines, simple profiles, and longevity.

Working with Taymor is always seamless. They make quality products that are elegant, affordable, and that complement the overall palette of our units while adding a touch of excitement.

**NED DODINGTON**  
DIRECTOR OF DEVELOPMENT & DESIGN  
GREYSTAR REAL ESTATE PARTNERS



## *Trusted* by Professional Builders

With decades of experience, we know the challenges residential construction projects face and the level of service builders and their project teams demand. We use our deep expertise in new construction to understand project needs, anticipate and solve issues, and deliver easy solutions.



**DOOR  
HARDWARE**

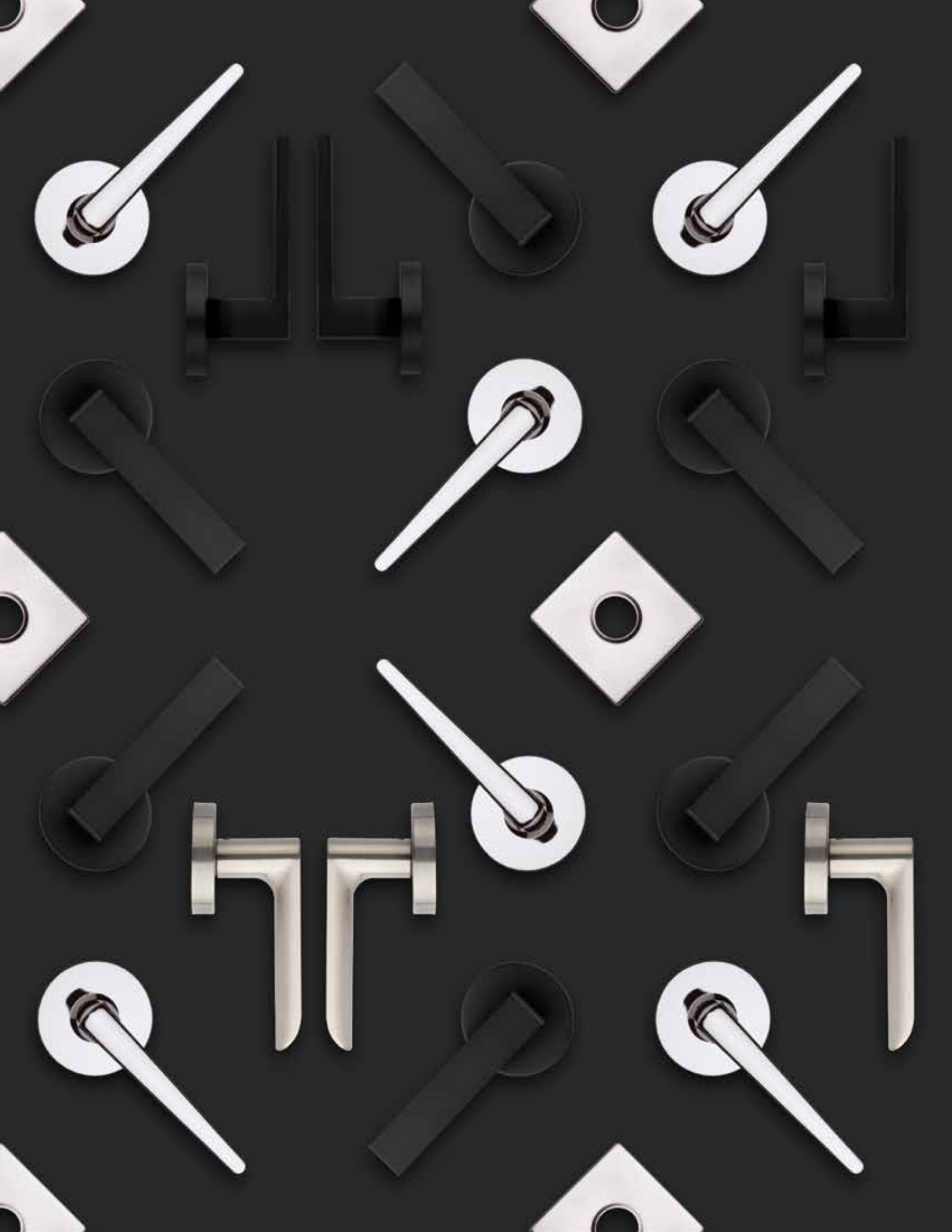



# THE PREMIER LINE

True to our tradition the Premier Line offers the design, quality and value you need with security, performance, and durability you can trust. From modern interior levers with collarless rose to solid Grade 1 certified mortise locks; our complete portfolio of Premier door hardware solutions makes it easy to accentuate any interior design and set multi-family building projects apart.





**INTRODUCING  
FULL BLOOM**

# Ahead of the *Curve*





FULL BLOOM LEVER & PREMIER DEADBOLT IN MATTE BLACK FOR DEADBOLTS SEE PAGE 57



## FULL BLOOM New!

Introducing Full Bloom, a cultivated new collection that is refined and sculptural. An organic collection all about comfort and curves.

### Notes

- Reversible lock
- Universal 6-in-1 latches offer a guaranteed fit
- Push button auto-release on privacy function
- Concealed screw mount for a streamlined look
- Premium all metal construction
- Fits standard doors 1-3/8" - 1-3/4"



**ANSI GRADE 3**



**MEETS  
ADA STANDARDS**



**FIRE RATING AVAILABLE**

Optional 20-minute fire rating. A fire can must be ordered in conjunction with lockset (see pg. 121).



**EXTENSION KIT AVAILABLE**

Optional Extension Kit works to accommodate doors that are 2-1/4" thick (see pg. 118).

### FULL BLOOM BOX PACK

ROUND	PRIVACY	PASSAGE 	DUMMY
SATIN NICKEL 15	30-D007624SN <b>\$145.92</b>	30-D007634SN <b>\$132.56</b>	30-764SN <b>\$69.96</b>
MATTE BLACK 19	30-D007624BLK <b>\$145.92</b>	30-D007634BLK <b>\$132.56</b>	30-764BLK <b>\$69.96</b>
POLISHED CHROME 26	30-D007624PC <b>\$145.92</b>	30-D007634PC <b>\$132.56</b>	30-764PC <b>\$69.96</b>
<b>SQUARE</b>			
SATIN NICKEL 15	30-D007724SN <b>\$145.92</b>	30-D007734SN <b>\$132.56</b>	30-774SN <b>\$69.96</b>
MATTE BLACK 19	30-D007724BLK <b>\$145.92</b>	30-D007734BLK <b>\$132.56</b>	30-774BLK <b>\$69.96</b>
POLISHED CHROME 26	30-D007724PC <b>\$145.92</b>	30-D007734PC <b>\$132.56</b>	30-774PC <b>\$69.96</b>

CASE QTY. 20



ARC DECO LEVER IN MATTE BLACK AND SATIN NICKEL

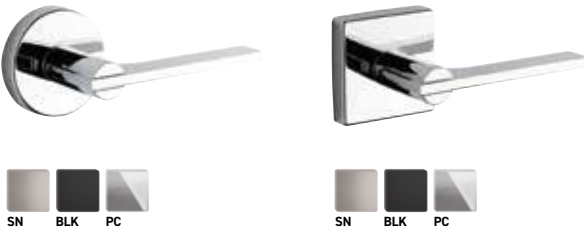

## ARC DECO

Defined arcs, elegant profiles and sleek sculptural forms, the Arc Deco lever embraces the simplicity and elegance of pure shape.

### Notes

Reversible lock	Universal 6-in-1 latches offer a guaranteed fit	Push button auto-release on privacy function	Concealed screw mount for a streamlined look	Premium all metal construction	Fits standard doors 1-3/8" - 1-3/4"
-----------------	---	--	--	--------------------------------	-------------------------------------



**ANSI GRADE 3**



**MEETS ADA STANDARDS**



**FIRE RATING AVAILABLE**

Optional 20-minute fire rating. A fire can must be ordered in conjunction with lockset (see pg. 121).



**EXTENSION KIT AVAILABLE**

Optional Extension Kit works to accommodate doors that are 2-1/4" thick (see pg. 118).

### ARC DECO BOX PACK

ROUND	PRIVACY	PASSAGE	DUMMY
SATIN NICKEL 15	30-D007424SN <b>\$138.60</b>	30-D007434SN <b>\$125.98</b>	30-744SN <b>\$65.82</b>
MATTE BLACK 19	30-D007424BLK <b>\$138.60</b>	30-D007434BLK <b>\$125.98</b>	30-744BLK <b>\$65.82</b>
POLISHED CHROME 26	30-D007424PC <b>\$138.60</b>	30-D007434PC <b>\$125.98</b>	30-744PC <b>\$65.82</b>
SQUARE			
SATIN NICKEL 15	30-D007524SN <b>\$138.60</b>	30-D007534SN <b>\$125.98</b>	30-754SN <b>\$65.82</b>
MATTE BLACK 19	30-D007524BLK <b>\$138.60</b>	30-D007534BLK <b>\$125.98</b>	30-754BLK <b>\$65.82</b>
POLISHED CHROME 26	30-D007524PC <b>\$138.60</b>	30-D007534PC <b>\$125.98</b>	30-754PC <b>\$65.82</b>

CASE QTY. 20

SEE PAGES 128-129 FOR COORDINATING BATHWARE



SLIP STREAM LEVER IN MATTE BLACK AND SATIN NICKEL



## SLIP STREAM

Effortless, fluid and streamlined design; the Slip Stream lever brings a refreshed modern look to your interiors with a refined combination of soft angles and distinctive slope detailing.

### Notes

Reversible lock

Universal 6-in-1 latches offer a guaranteed fit

Push button auto-release on privacy function

Concealed screw mount for a streamlined look

Premium all metal construction

Fits standard doors 1-3/8" - 1-3/4"



**ANSI GRADE 3**



**MEETS ADA STANDARDS**



**FIRE RATING AVAILABLE**

Optional 20-minute fire rating. A fire can must be ordered in conjunction with lockset (see pg. 121).



**EXTENSION KIT AVAILABLE**

Optional Extension Kit works to accommodate doors that are 2-1/4" thick (see pg. 118).

### SLIP STREAM BOX PACK

ROUND	PRIVACY	PASSAGE 	DUMMY
SATIN NICKEL 15	30-D007224SN <b>\$122.40</b>	30-D007234SN <b>\$111.30</b>	30-724SN <b>\$59.23</b>
MATTE BLACK 19	30-D007224BLK <b>\$122.40</b>	30-D007234BLK <b>\$111.30</b>	30-724BLK <b>\$59.23</b>
POLISHED CHROME 26	30-D007224PC <b>\$122.40</b>	30-D007234PC <b>\$111.30</b>	30-724PC <b>\$59.23</b>
SQUARE			
SATIN NICKEL 15	30-D007324SN <b>\$122.40</b>	30-D007334SN <b>\$111.30</b>	30-734SN <b>\$59.23</b>
MATTE BLACK 19	30-D007324BLK <b>\$122.40</b>	30-D007334BLK <b>\$111.30</b>	30-734BLK <b>\$59.23</b>
POLISHED CHROME 26	30-D007324PC <b>\$122.40</b>	30-D007334PC <b>\$111.30</b>	30-734PC <b>\$59.23</b>

CASE QTY. 20

SEE PAGES 130-131 FOR COORDINATING BATHWARE



1948 LEVER IN POLISHED CHROME, SATIN NICKEL AND MATTE BLACK



## 1948

A crisp, square profile with collarless rose and subtle ergonomic curve on the back of the 1948 lever, present a minimalistic soft-square outline that feels good in the hand.

### Notes

Reversible lock	Universal 6-in-1 latches offer a guaranteed fit	Push button auto-release on privacy function	Concealed screw mount for a streamlined look	Premium all metal construction	Fits standard doors 1-3/8" - 1-3/4"
-----------------	---	--	--	--------------------------------	-------------------------------------



**ANSI GRADE 3**



**MEETS ADA STANDARDS**



**FIRE RATING AVAILABLE**

Optional 20-minute fire rating. A fire can must be ordered in conjunction with lockset (see pg. 121).



**EXTENSION KIT AVAILABLE**

Optional Extension Kit works to accommodate doors that are 2-1/4" thick (see pg. 118).

### 1948 LEVER BOX PACK

ROUND ROSE	PRIVACY	PASSAGE 	DUMMY
SATIN NICKEL 15	30-D007024SN <b>\$145.92</b>	30-D007034SN <b>\$132.56</b>	30-704SN <b>\$69.96</b>
MATTE BLACK 19	30-D007024BLK <b>\$145.92</b>	30-D007034BLK <b>\$132.56</b>	30-704BLK <b>\$69.96</b>
POLISHED CHROME 26	30-D007024PC <b>\$145.92</b>	30-D007034PC <b>\$132.56</b>	30-704PC <b>\$69.96</b>
SQUARE ROSE			
SATIN NICKEL 15	30-D007124SN <b>\$145.92</b>	30-D007134SN <b>\$132.56</b>	30-714SN <b>\$69.96</b>
MATTE BLACK 19	30-D007124BLK <b>\$145.92</b>	30-D007134BLK <b>\$132.56</b>	30-714BLK <b>\$69.96</b>
POLISHED CHROME 26	30-D007124PC <b>\$145.92</b>	30-D007134PC <b>\$132.56</b>	30-714PC <b>\$69.96</b>

CASE QTY. 20

SEE PAGES 132-133 FOR COORDINATING BATHWARE

# PREMIER LOCKSETS

## Vega - Square Rose



## Vega - Round Rose



## Equinox - Square Rose



## Equinox - Round Rose

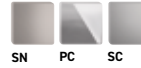

### VEGA - SQUARE ROSE

BOX PACK	PRIVACY	PASSAGE 	DUMMY
SATIN NICKEL 15	30-D006724SN <b>\$116.62</b>	30-D006734SN <b>\$106.05</b>	30-674SN <b>\$56.44</b>
MATTE BLACK 19	30-D006724BLK <b>\$116.62</b>	30-D006734BLK <b>\$106.05</b>	30-674BLK <b>\$56.44</b>
POLISHED CHROME 26	30-D006724PC <b>\$116.62</b>	30-D006734PC <b>\$106.05</b>	30-674PC <b>\$56.44</b>
SATIN CHROME 26D	30-D006724SC <b>\$116.62</b>	30-D006734SC <b>\$106.05</b>	30-674SC <b>\$56.44</b>

CASE QTY. 20

### VEGA - ROUND ROSE

BOX PACK	PRIVACY	PASSAGE 	INSIDE TRIM	DUMMY
SATIN NICKEL 15	30-D006424SN <b>\$116.62</b>	30-D006434SN <b>\$106.05</b>	30-HL0064SN <b>\$74.34</b>	30-644SN <b>\$56.44</b>
MATTE BLACK 19	30-D006424BLK <b>\$116.62</b>	30-D006434BLK <b>\$106.05</b>	30-HL0064BLK <b>\$74.34</b>	30-644BLK <b>\$56.44</b>
POLISHED CHROME 26	30-D006424PC <b>\$116.62</b>	30-D006434PC <b>\$106.05</b>	30-HL0064PC <b>\$74.34</b>	30-644PC <b>\$56.44</b>
SATIN CHROME 26D	30-D006424SC <b>\$116.62</b>	30-D006434SC <b>\$106.05</b>	30-HL0064SC <b>\$74.34</b>	30-644SC <b>\$56.44</b>

CASE QTY. 20

### EQUINOX - SQUARE ROSE

BOX PACK	PRIVACY	PASSAGE 	INSIDE TRIM	DUMMY
SATIN NICKEL 15	30-D006824SN <b>\$101.55</b>	30-D006834SN <b>\$92.23</b>	-	30-684SN <b>\$46.27</b>
POLISHED CHROME 26	30-D006824PC <b>\$101.55</b>	30-D006834PC <b>\$92.23</b>	-	30-684PC <b>\$46.27</b>
SATIN CHROME 26D	30-D006824SC <b>\$101.55</b>	30-D006834SC <b>\$92.23</b>	-	30-684SC <b>\$46.27</b>

CASE QTY. 20

### EQUINOX - ROUND ROSE

BOX PACK	PRIVACY	PASSAGE 	INSIDE TRIM	DUMMY
SATIN NICKEL 15	30-D004424SN <b>\$101.55</b>	30-D004434SN <b>\$92.33</b>	30-HL0044SN <b>\$64.69</b>	30-444SN <b>\$46.27</b>
POLISHED CHROME 26	30-D004424PC <b>\$101.55</b>	30-D004434PC <b>\$92.33</b>	30-HL0044PC <b>\$64.69</b>	30-444PC <b>\$46.27</b>
SATIN CHROME 26D	30-D004424SC <b>\$101.55</b>	30-D004434SC <b>\$92.33</b>	30-HL0044SC <b>\$64.69</b>	30-444SC <b>\$46.27</b>

CASE QTY. 20

#### VISUAL PACK

SATIN NICKEL 15	31-FV004424SN <b>\$105.11</b>	31-FV004434SN <b>\$95.88</b>	-	-
POLISHED CHROME 26	31-FV004424PC <b>\$ 93.55</b>	31-FV004434PC <b>\$85.34</b>	-	-
SATIN CHROME 26D	31-FV004424SC <b>\$ 93.55</b>	31-FV004434SC <b>\$85.34</b>	-	-

CASE QTY. 4

**Bergen**



**Britannia**

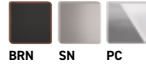

**Stockholm**



**Barcelona**



**BERGEN**

BOX PACK	PRIVACY	PASSAGE 	INSIDE TRIM	DUMMY
SATIN NICKEL 15	30-D006224SN <b>\$109.99</b>	30-D006234SN <b>\$100.04</b>	30-HL0062SN <b>\$69.94</b>	30-624SN <b>\$53.59</b>
MATTE BLACK 19	30-D006224BLK <b>\$109.99</b>	30-D006234BLK <b>\$100.04</b>	30-HL0062BLK <b>\$69.94</b>	30-624BLK <b>\$53.59</b>
POLISHED CHROME 26	30-D006224PC <b>\$109.99</b>	30-D006234PC <b>\$100.04</b>	30-HL0062PC <b>\$69.94</b>	30-624PC <b>\$53.59</b>
SATIN CHROME 26D	30-D006224SC <b>\$109.99</b>	30-D006234SC <b>\$100.04</b>	30-HL0062SC <b>\$69.94</b>	30-624SC <b>\$53.59</b>

CASE QTY. 20

**BRITANNIA**

\*PLEASE SELECT "R" OR "L" FOR RIGHT OR LEFT HANDING AT END OF ITEM NUMBER WHEN ORDERING INSIDE TRIM & DUMMIES

BOX PACK	PRIVACY	PASSAGE 	INSIDE TRIM*	DUMMY*
AGED BRONZE 10B+	30-D006324BRN <b>\$120.89</b>	30-D006334BRN <b>\$109.99</b>	30-HL0063BRN__ <b>\$76.89</b>	30-634BRN__ <b>\$58.67</b>
SATIN NICKEL 15	30-D006324SN <b>\$109.99</b>	30-D006334SN <b>\$ 99.85</b>	30-HL0063SN__ <b>\$69.94</b>	30-634SN__ <b>\$53.59</b>
POLISHED CHROME 26	30-D006324PC <b>\$109.99</b>	30-D006334PC <b>\$ 99.85</b>	30-HL0063PC__ <b>\$69.94</b>	30-634PC__ <b>\$53.59</b>
CASE QTY. 20				
VISUAL PACK				
SATIN NICKEL 15	31-FV006324SN <b>\$113.57</b>	31-FV006334SN <b>\$103.60</b>	—	—
CASE QTY. 4				

**STOCKHOLM**

BOX PACK	PRIVACY	PASSAGE 	INSIDE TRIM	DUMMY
SATIN NICKEL 15	30-D004924SN <b>\$109.99</b>	30-D004934SN <b>\$99.86</b>	30-HL0049SN <b>\$69.94</b>	30-494SN <b>\$53.59</b>
POLISHED CHROME 26	30-D004924PC <b>\$109.99</b>	30-D004934PC <b>\$99.86</b>	30-HL0049PC <b>\$69.94</b>	30-494PC <b>\$53.59</b>

CASE QTY. 20

**BARCELONA**

BOX PACK	PRIVACY	PASSAGE 	INSIDE TRIM	DUMMY
SATIN NICKEL 15	30-D006124SN <b>\$84.97</b>	30-D006134SN <b>\$77.28</b>	30-HL0061SN <b>\$53.95</b>	30-614SN <b>\$38.72</b>
MATTE BLACK 19	30-D006124BLK <b>\$84.97</b>	30-D006134BLK <b>\$77.28</b>	30-HL0061BLK <b>\$53.95</b>	30-614BLK <b>\$38.72</b>

CASE QTY. 20



## Rose Kits

Customize your style with an optional, Square Contemporary Rose Kit on Taymor levers that come standard with round rose. Clean, distinct lines give a modern edge to any space. Conveniently, a special mounting bracket makes it easy to fine-tune the square rose during installation so that it aligns perfectly with the linear features and edges of your door.

### COMPATIBLE WITH THE PREMIER LINE OF LOCKSETS



LEVER



SQUARE ROSE



CUSTOM STYLING



#### Notes

Concealed mount for a streamlined look

Premium all metal construction

High quality finish options

#### SQUARE CONTEMPORARY ROSE KIT

BOX PACK	PRIVACY	PASSAGE	DUMMY
AGED BRONZE 10B+	30-SQR0024BRN <b>\$12.21</b>	30-SQR0034BRN <b>\$12.22</b>	30-SQR0044BRN <b>\$9.77</b>
SATIN NICKEL 15	30-SQR0024SN <b>\$ 9.77</b>	30-SQR0034SN <b>\$ 9.77</b>	30-SQR0044SN <b>\$7.32</b>
MATTE BLACK 19	30-SQR0024BLK <b>\$ 9.77</b>	30-SQR0034BLK <b>\$ 9.77</b>	30-SQR0044BLK <b>\$7.32</b>
POLISHED CHROME 26	30-SQR0024PC <b>\$ 9.77</b>	30-SQR0034PC <b>\$ 9.77</b>	30-SQR0044PC <b>\$7.32</b>
SATIN CHROME 26D	30-SQR0024SC <b>\$ 9.77</b>	30-SQR0034SC <b>\$ 9.77</b>	30-SQR0044SC <b>\$7.32</b>
CASE QTY. 10			



**Premier Line Flush Deadbolts**



GRADE 2

**ANSI GRADE 2**



**MEETS ADA STANDARDS**



**FIRE RATING AVAILABLE**

Optional 20-minute fire rating. A fire can must be ordered in conjunction with the deadbolt.



**FULL KEYING SERVICES AVAILABLE**

6-pin SC4 keyway, packaged keyed alike - KA3

**Notes**

- › Concealed screw mount for a streamlined look
- › Includes anti-pry collar for reinforced security
- › Universal 6-in-1 latches offer a guaranteed fit
- › High tensile steel anti-saw deadbolt with 1" (25 mm) throw
- › Fits standard exterior doors

**SQUARE DEADBOLT**

BOX PACK - KA3			
SATIN NICKEL 15	30-D01SC406SN		<b>\$104.75</b>
MATTE BLACK 19	30-D01SC406BLK		<b>\$104.75</b>
POLISHED CHROME 26	30-D01SC406PC		<b>\$104.75</b>
SATIN CHROME 26D	30-D01SC406SC		<b>\$104.75</b>
CASE QTY. 9			

**ROUND DEADBOLT**

BOX PACK - KA3			
SATIN NICKEL 15	30-D01SC408SN		<b>\$104.75</b>
MATTE BLACK 19	30-D01SC408BLK		<b>\$104.75</b>
POLISHED CHROME 26	30-D01SC408PC		<b>\$104.75</b>
SATIN CHROME 26D	30-D01SC408SC		<b>\$104.75</b>
CASE QTY. 9			

**Premier Line Standard Deadbolts**

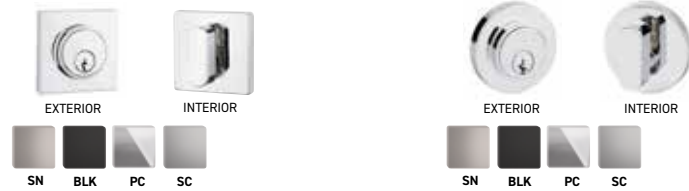

GRADE 2

**ANSI GRADE 2**



**MEETS ADA STANDARDS**



**FIRE RATING AVAILABLE**

Optional 20-minute fire rating. A fire can must be ordered in conjunction with the deadbolt.



**FULL KEYING SERVICES AVAILABLE**

6-pin SC4 keyway, packaged keyed alike - KA3

**Notes**

- › Includes anti-pry collar for reinforced security
- › Universal 6-in-1 latches offer a guaranteed fit
- › High tensile steel anti-saw deadbolt with 1" (25 mm) throw
- › Fits standard exterior doors

**SQUARE DEADBOLT**

BOX PACK - KA3			
SATIN NICKEL 15	30-D01SC402SN		<b>\$124.08</b>
MATTE BLACK 19	30-D01SC402BLK		<b>\$124.08</b>
POLISHED CHROME 26	30-D01SC402PC		<b>\$124.08</b>
SATIN CHROME 26D	30-D01SC402SC		<b>\$124.08</b>
CASE QTY. 9			

**ROUND DEADBOLT**

BOX PACK - KA3			
SATIN NICKEL 15	30-D01SC404SN		<b>\$124.08</b>
MATTE BLACK 19	30-D01SC404BLK		<b>\$124.08</b>
POLISHED CHROME 26	30-D01SC404PC		<b>\$124.08</b>
SATIN CHROME 26D	30-D01SC404SC		<b>\$124.08</b>
CASE QTY. 9			

**Premier Line Standard Deadbolts - Retail**



GRADE 3

**ANSI GRADE 3**



**MEETS ADA STANDARDS**



**FULL KEYING SERVICES AVAILABLE**

5-pin WR5 keyway, packaged keyed different

**Notes**

- › Includes anti-pry collar for reinforced security
- › Universal 6-in-1 latches offer a guaranteed fit
- › High tensile steel anti-saw deadbolt with 1" (25 mm) throw
- › Fits standard exterior doors

**RETAIL SQUARE DEADBOLT**

VISUAL PACK - KD			
SATIN NICKEL 15	31-FV01WR502SN		<b>\$107.57</b>
MATTE BLACK 19	31-FV01WR502BLK		<b>\$107.56</b>
POLISHED CHROME 26	31-FV01WR502PC		<b>\$107.57</b>
CASE QTY. 4			

**RETAIL ROUND DEADBOLT**

VISUAL PACK - KD			
SATIN NICKEL 15	31-FV01WR504SN		<b>\$107.57</b>
MATTE BLACK 19	31-FV01WR504BLK		<b>\$107.56</b>
POLISHED CHROME 26	31-FV01WR504PC		<b>\$107.57</b>
CASE QTY. 4			



## Mortise Locks

Taymor Mortise Locks are designed and constructed to provide the ultimate in security and performance. With quality finish options, ANSI Grade 1 security, and a 3-hour fire rating, they're one of the strongest and longest lasting locks available.

# 1

### CHOOSE YOUR LEVER

Select from five of our top-selling Premier Line levers—Bergen, Britannia, Slip Stream, Stockholm or Vega—for a wide range of architectural style and expression.

# 2

### CHOOSE YOUR TRIM

Select from three different trim formats: escutcheon trim, round sectional trim and square sectional trim.

# 3

### CHOOSE YOUR FINISH

Select from four durable finishes: Satin Nickel, Matte Black, Polished Chrome, or Satin Chrome.

# 4

### CHOOSE YOUR CYLINDER\*

Standard 6-pin SC4 keyway: 1-1/8" length for sectional and 1-1/4" length for escutcheon configurations.

#### Notes

Cylinder\*: cylinder sold separately

Deadbolt: **solid brass** with two hardened steel pins; 1" (25 mm) projection

Latchbolt: stainless steel with two anti-friction tongues; 3/4" (18 mm) field reversible throw



ANSI GRADE 1



MEETS  
ADA STANDARDS



FULL KEYING SERVICES  
AVAILABLE

6-pin SC4 keyway, packaged keyed different



FIRE RATED

Meets c-UL 3-hour fire rating standard



ARC DECO MORTISE    BERGEN MORTISE    BRITANNIA MORTISE    SLIP STREAM MORTISE    STOCKHOLM MORTISE    VEGA MORTISE



WITH ESCUTCHEON TRIM



WITH ROUND SECTIONAL TRIM

All items listed below are ANSI Function #F13 (Dormitory) for suite entry and home entry door applications.

ARC DECO MORTISE	ESCUTCHEON TRIM		ROUND SECTIONAL TRIM	
	MATTE BLACK 19	39-E5682C19	<b>\$939.38</b>	39-S5682C19
POLISHED CHROME 26	39-E5682C26	<b>\$939.38</b>	39-S5682C26	<b>\$798.48</b>

BERGEN MORTISE	ESCUTCHEON TRIM		ROUND SECTIONAL TRIM	
	SATIN NICKEL 15	39-E5666C15	<b>\$939.38</b>	39-S5666C15
MATTE BLACK 19	39-E5666C19	<b>\$939.38</b>	39-S5666C19	<b>\$798.48</b>
POLISHED CHROME 26	39-E5666C26	<b>\$939.38</b>	39-S5666C26	<b>\$798.48</b>
SATIN CHROME 26D	39-E5666C26D	<b>\$939.38</b>	39-S5666C26D	<b>\$798.48</b>

BRITANNIA MORTISE	ESCUTCHEON TRIM*		ROUND SECTIONAL TRIM*	
	SATIN NICKEL 15	39-E5644C15__	<b>\$939.38</b>	39-S5644C15__
POLISHED CHROME 26	39-E5644C26__	<b>\$939.38</b>	39-S5644C26__	<b>\$798.48</b>

\*PLEASE SELECT "R" OR "L" FOR RIGHT OR LEFT HANDING AT END OF ITEM NUMBER WHEN ORDERING

STOCKHOLM MORTISE	ESCUTCHEON TRIM		ROUND SECTIONAL TRIM	
	SATIN NICKEL 15	39-E5622C15	<b>\$939.38</b>	39-S5622C15
POLISHED CHROME 26	39-E5622C26	<b>\$939.38</b>	39-S5622C26	<b>\$798.48</b>
SATIN CHROME 26D	39-E5622C26D	<b>\$939.38</b>	39-S5622C26D	<b>\$798.48</b>

SLIP STREAM MORTISE	ESCUTCHEON TRIM		ROUND SECTIONAL TRIM	
	SATIN NICKEL 15	39-E5672C15	<b>\$939.38</b>	39-S5672C15
MATTE BLACK 19	39-E5672C19	<b>\$939.38</b>	39-S5672C19	<b>\$798.48</b>
POLISHED CHROME 26	39-E5672C26	<b>\$939.38</b>	39-S5672C26	<b>\$798.48</b>

VEGA MORTISE	ESCUTCHEON TRIM		ROUND SECTIONAL TRIM		SQUARE SECTIONAL TRIM VEGA MORTISE ONLY	
	SATIN NICKEL 15	39-E5633C15	<b>\$939.38</b>	39-S5633C15	<b>\$798.48</b>	39-SQ5633C15
MATTE BLACK 19	39-E5633C19	<b>\$939.38</b>	39-S5633C19	<b>\$798.48</b>	39-SQ5633C19	<b>\$798.48</b>
POLISHED CHROME 26	39-E5633C26	<b>\$939.38</b>	39-S5633C26	<b>\$798.48</b>	39-SQ5633C26	<b>\$798.48</b>
SATIN CHROME 26D	39-E5633C26D	<b>\$939.38</b>	39-S5633C26D	<b>\$798.48</b>	39-SQ5633C26D	<b>\$798.48</b>

CYLINDERS (SOLD SEPARATELY)	ESCUTCHEON TRIM		SECTIONAL TRIM		Cylinders may be compatible with other brands. Contact Taymor for details.
	SC4 "C" 6-PIN KEYWAY, 1-1/4" (32 mm)		SC4 "C" 6-PIN KEYWAY, 1-1/8" (28 mm)		
SATIN NICKEL 15	39-MSCYL114C15	<b>\$72.26</b>	39-MSCYL118C15	<b>\$72.26</b>	
MATTE BLACK 19	39-MSCYL114C19	<b>\$72.26</b>	39-MSCYL118C19	<b>\$72.26</b>	
POLISHED CHROME 26	39-MSCYL114C26	<b>\$72.26</b>	39-MSCYL118C26	<b>\$72.26</b>	
SATIN CHROME 26D	39-MSCYL114C26D	<b>\$72.26</b>	39-MSCYL118C26D	<b>\$72.26</b>	

See page 104 for replacement cloverleaf cam for above cylinders.  
 Minimum quantities and lead times apply. Taymor Mortise cylinders may be compatible with other brands.  
 Please contact your Taymor sales representative for details.



## Interconnected Locks

With its modern design and soft square lines, the Taymor Premier Interconnected lock is a departure from standard commercial-style offerings. Designed for multi-family housing or anywhere simultaneous retraction is required. It can also be combined with select Premier Line levers, offering a wide array different combinations of style, trim, and finish options.





1

Simultaneous retraction: simply press the lever to unlock and open your door from inside

2

Interchangeable with most Taymor Premier Line levers

3

Easily harmonize interior levers to coordinate with the unit entry door

4

Concealed screw mount for a streamlined look

**Interior**



**Exterior with Square or Round Rose**



**Finishes**



**Notes**

**2**  
ANSI GRADE 2

 **LIMITED LIFETIME MECHANICAL & FINISH WARRANTY**

 **MEETS ADA STANDARDS**

 **FULL KEYING SERVICES AVAILABLE**  
6-pin SC4 keyway, packaged keyed different

 **FIRE RATED**  
Meets UL 3-hour fire rating standard

 **REFER TO NEXT PAGE FOR ITEM NUMBERS AND ORDERING CHART**

TAYMOR® PREMIER INTERCONNECTED LOCKS

TAYMOR® PREMIER INTERCONNECTED LOCK

STOCKED ITEMS

	EXTERIOR TRIM	INTERIOR TRIM	SQUARE ROSE		ROUND ROSE	
SATIN NICKEL 15	ARC DECO	ARC DECO	30-INTSQ74SN	\$414.00	30-INTRD74SN	\$414.00
	BERGEN	BERGEN	30-INTSQ62SN	\$414.00	30-INTRD62SN	\$414.00
	SLIP STREAM	SLIP STREAM	30-INTSQ72SN	\$414.00	30-INTRD72SN	\$414.00
	VEGA	VEGA	30-INTSQ64SN	\$414.00	30-INTRD64SN	\$414.00
MATTE BLACK 19	ARC DECO	ARC DECO	30-INTSQ74BLK	\$414.00	30-INTRD74BLK	\$414.00
	BERGEN	BERGEN	30-INTSQ62BLK	\$414.00	30-INTRD62BLK	\$414.00
	SLIP STREAM	SLIP STREAM	30-INTSQ72BLK	\$414.00	30-INTRD72BLK	\$414.00
	VEGA	VEGA	30-INTSQ64BLK	\$414.00	30-INTRD64BLK	\$414.00
POLISHED CHROME 26	ARC DECO	ARC DECO	30-INTSQ74PC	\$414.00	30-INTRD74PC	\$414.00
	BERGEN	BERGEN	30-INTSQ62PC	\$414.00	30-INTRD62PC	\$414.00
	SLIP STREAM	SLIP STREAM	30-INTSQ72PC	\$414.00	30-INTRD72PC	\$414.00
	VEGA	VEGA	30-INTSQ64PC	\$414.00	30-INTRD64PC	\$414.00

CUSTOM FINISH/TRIM TAYMOR® PREMIER INTERCONNECTED LOCK

SPECIAL ORDER ITEMS

Minimum quantity of 60 pieces and 100 day lead time applies to all custom finish/trim orders

HOW TO ORDER

Add desired style, trim, and finish code to the item number [30-INT]

Please note: the cells highlighted in the tables below are for illustrative purposes only.

PREMIER	STYLE	EXTERIOR TRIM	INTERIOR TRIM	EXTERIOR FINISH		INTERIOR FINISH		DOOR HANDING*
30-INT	SQ SQUARE ROSE	74 ARC DECO	74 ARC DECO	BRN	AGED BRONZE	BRN	AGED BRONZE	R RIGHT HANDED
	RD ROUND ROSE	62 BERGEN	62 BERGEN	SN	SATIN NICKEL	SN	SATIN NICKEL	L LEFT HANDED
		63 BRITANNIA	63 BRITANNIA	BLK	MATTE BLACK	BLK	MATTE BLACK	
		76 FULL BLOOM	76 FULL BLOOM	SC	SATIN CHROME	SC	SATIN CHROME	
		44 EQUINOX	44 EQUINOX	PC	POLISHED CHROME	PC	POLISHED CHROME	
		72 SLIP STREAM	72 SLIP STREAM					
		49 STOCKHOLM	49 STOCKHOLM					
		64 VEGA	64 VEGA					
	*Specify door handing for Britannia	63 BRITANNIA*	63 BRITANNIA*	SATIN NICKEL 15 \$414.00 AGED BRONZE 10B+ \$450.00 POLISHED CHROME 26 \$414.00		SATIN CHROME 26D \$414.00 MATTE BLACK 19 \$414.00		

FOR EXAMPLE

30 - I N T R D 6 3 6 2 S N P C L

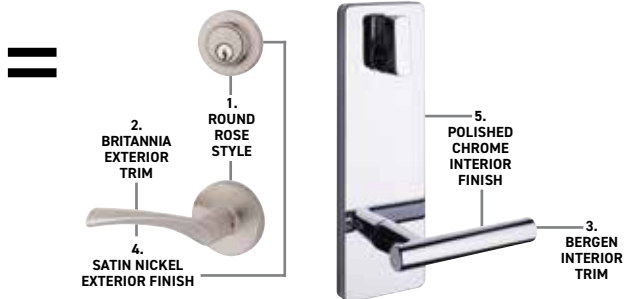
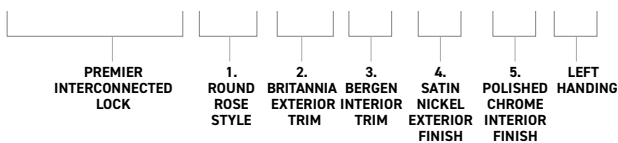



OPTIONAL SQUARE ROSE TRIM AVAILABLE (see pg. 120 for customization options)

VEGA INTERIOR TRIM & DEADBOLT



## THE LONDON HANDLESET

Crisp, modern and bold; our exclusive London handleset can go Modern, Craftsman or Mission style. Its substantial presence and proportions make it perfect for a grand entrance. Featuring linear styling with concealed screw mounts and solid Grade 2 security; this heavy-duty lock also includes our Premier Vega lever on the interior.

### Notes

Coordinates with a broad array of Taymor exterior hardware

Compatible with all Taymor Premier Line locksets for interior trim

Universal 6-in-1 latches offer a guaranteed fit

Includes anti-pry collar for reinforced security

Deadbolt fits 2-1/8" (54 mm) or 1-1/2" (38 mm) bore hole

Fits standard exterior doors



**ANSI GRADE 2**



**FULL KEYING SERVICES AVAILABLE**

WR5 keyway, packaged keyed different



**EXTENSION KIT AVAILABLE**

Optional Extension Kit works to accommodate doors that are 2-1/4" thick (see pg. 118).

### LONDON WITH VEGA INTERIOR TRIM

**BOX PACK**

SATIN NICKEL 15	30-D1015SN	\$483.25
MATTE BLACK 19	30-D1015BLK	\$483.25
POLISHED CHROME 26	30-D1015PC	\$483.25
SATIN CHROME 26D	30-D1015SC	\$483.25

CASE QTY. 4

**VISUAL PACK**

SATIN NICKEL 15	31-FV1015SN	\$510.90
MATTE BLACK 19	31-FV1015BLK	\$510.90

CASE QTY. 4





# Professional *Select*

Comprised of four lever style options, a new entry handle set, and a redesigned deadbolt, this modern series features streamlined designs and superb functionality perfectly suited for modern spaces.



(LEFT) LEADING EDGE HANDLESET IN MATTE BLACK  
(ABOVE) FREE STYLE LEVER IN POLISHED CHROME

PROFESSIONAL SELECT

Ramp Up **New!**



Free Style **New!**



Pace Line - Round Rose



Pace Line - Square Rose



Notes

Reversible lock

Universal 6-in-1 latches offer a guaranteed fit

Push button auto-release on privacy function,  
turn button auto-release on entry function

Premium all-metal construction

Fits standard doors 1-3/8" - 1-3/4"



ANSI GRADE 3



FULL KEYING SERVICES AVAILABLE

WR5 keyway, packaged keyed different



MEETS ADA STANDARDS



NON-FIRE RATED

RAMP UP

BOX PACK	ENTRY - KD		PRIVACY		PASSAGE		DUMMY*	
SATIN NICKEL 15	33-D009364SN	\$112.60	33-D009324SN	\$88.53	33-D009334SN	\$77.67	33-934SN	\$38.83
MATTE BLACK 19	33-D009364BLK	\$112.60	33-D009324BLK	\$88.53	33-D009334BLK	\$77.67	33-934BLK	\$38.83
POLISHED CHROME 26	33-D009364PC	\$112.60	33-D009324PC	\$88.53	33-D009334PC	\$77.67	33-934PC	\$38.83
CASE QTY. 20 *CASE QTY. 30								
VISUAL PACK								
SATIN NICKEL 15	34-FV009364SN	\$127.39	34-FV009324SN	\$100.15	34-FV009334SN	\$87.85	—	—
MATTE BLACK 19	34-FV009364BLK	\$127.39	34-FV009324BLK	\$100.15	34-FV009334BLK	\$87.85	—	—
CASE QTY. 4								

FREE STYLE

BOX PACK	ENTRY - KD		PRIVACY		PASSAGE		DUMMY*	
SATIN NICKEL 15	33-D009464SN	\$112.60	33-D009424SN	\$88.53	33-D009434SN	\$77.67	33-944SN	\$38.83
MATTE BLACK 19	33-D009464BLK	\$112.60	33-D009424BLK	\$88.53	33-D009434BLK	\$77.67	33-944BLK	\$38.83
POLISHED CHROME 26	33-D009464PC	\$112.60	33-D009424PC	\$88.53	33-D009434PC	\$77.67	33-944PC	\$38.83
CASE QTY. 20 *CASE QTY. 30								
VISUAL PACK								
SATIN NICKEL 15	34-FV009464SN	\$127.39	34-FV009424SN	\$100.15	34-FV009434SN	\$87.85	—	—
MATTE BLACK 19	34-FV009464BLK	\$127.39	34-FV009424BLK	\$100.15	34-FV009434BLK	\$87.85	—	—
CASE QTY. 4								

PACE LINE - ROUND ROSE

BOX PACK	ENTRY - KD		PRIVACY		PASSAGE		DUMMY*	
SATIN NICKEL 15	33-D009164SN	\$112.60	33-D009124SN	\$88.53	33-D009134SN	\$77.67	33-914SN	\$38.83
MATTE BLACK 19	33-D009164BLK	\$112.60	33-D009124BLK	\$88.53	33-D009134BLK	\$77.67	33-914BLK	\$38.83
POLISHED CHROME 26	33-D009164PC	\$112.60	33-D009124PC	\$88.53	33-D009134PC	\$77.67	33-914PC	\$38.83
CASE QTY. 20 *CASE QTY. 30								
VISUAL PACK								
SATIN NICKEL 15	34-FV009164SN	\$127.39	34-FV009124SN	\$100.15	34-FV009134SN	\$87.85	—	—
MATTE BLACK 19	34-FV009164BLK	\$127.39	34-FV009124BLK	\$100.15	34-FV009134BLK	\$87.85	—	—
CASE QTY. 4								

PACE LINE - SQUARE ROSE

BOX PACK	ENTRY - KD		PRIVACY		PASSAGE		DUMMY*	
SATIN NICKEL 15	33-D009264SN	\$112.60	33-D009224SN	\$88.53	33-D009234SN	\$77.67	33-924SN	\$38.83
MATTE BLACK 19	33-D009264BLK	\$112.60	33-D009224BLK	\$88.53	33-D009234BLK	\$77.67	33-924BLK	\$38.83
POLISHED CHROME 26	33-D009264PC	\$112.60	33-D009224PC	\$88.53	33-D009234PC	\$77.67	33-924PC	\$38.83
CASE QTY. 20 *CASE QTY. 30								
VISUAL PACK								
SATIN NICKEL 15	34-FV009264SN	\$127.39	34-FV009224SN	\$100.15	34-FV009234SN	\$87.85	—	—
MATTE BLACK 19	34-FV009264BLK	\$127.39	34-FV009224BLK	\$100.15	34-FV009234BLK	\$87.85	—	—
CASE QTY. 4								

Cross Flow



CROSS FLOW

BOX PACK	ENTRY - KD		PRIVACY		PASSAGE		DUMMY*	
SATIN NICKEL 15	33-D009064SN	\$112.60	33-D009024SN	\$88.53	33-D009034SN	\$77.67	33-904SN	\$38.83
MATTE BLACK 19	33-D009064BLK	\$112.60	33-D009024BLK	\$88.53	33-D009034BLK	\$77.67	33-904BLK	\$38.83
POLISHED CHROME 26	33-D009064PC	\$112.60	33-D009024PC	\$88.53	33-D009034PC	\$77.67	33-904PC	\$38.83
CASE QTY. 20		*CASE QTY. 30						
VISUAL PACK								
SATIN NICKEL 15	34-FV009064SN	\$127.39	34-FV009024SN	\$100.15	34-FV009034SN	\$87.85	-	
CASE QTY. 4								

Professional Select Deadbolts New!



PROFESSIONAL SELECT DEADBOLTS

BOX PACK	ROUND ROSE		SQUARE ROSE	
SATIN NICKEL 15	33-D6064	\$90.00	33-D6074	\$90.00
MATTE BLACK 19	33-D6164	\$90.00	33-D6174	\$90.00
POLISHED CHROME 26	33-D6664	\$90.00	33-D6674	\$90.00
CASE QTY. 4				
VISUAL PACK				
SATIN NICKEL 15	34-FV606	\$87.00	34-FV607	\$87.00
MATTE BLACK 19	34-FV616	\$87.00	34-FV617	\$87.00
CASE QTY. 18				

Notes

Solid metal construction      Hardened "cut-proof" steel pin      High security strike standard

Deadbolt fits 2-1/8" (54 mm) bore hole      6-in-1 latch throw      Fits standard exterior doors

only      Two 3" (76 mm) strike screws for increased security

Leading Edge New!



PACE LINE INTERIOR LEVER

The Leading Edge handleset is only available with the Pace Line lever for the interior trim



Notes

Universal 6-in-1 latches offer a guaranteed fit      Premium all-metal construction      Fits standard 2-1/8" (54 mm) bore hole      Coordinates with a broad array of Taymor exterior hardware

Fits standard exterior doors



ANSI GRADE 3



FULL KEYING SERVICES AVAILABLE

WR5 keyway, packaged keyed different



MEETS ADA STANDARDS



NON-FIRE RATED

LEADING EDGE WITH PACE LINE LEVER - SQUARE ROSE

VISUAL PACK		
SATIN NICKEL 15	33-D9030	\$325.00
MATTE BLACK 19	33-D9010	\$325.00
POLISHED CHROME 26	33-D9020	\$325.00
CASE QTY. 10		



STRAIT HANDLESET WITH MODERN DOOR KNOCKER, MODERN NUMBERS AND KICK PLATE

# PROFESSIONAL SERIES®

Form meets function in our Professional Series® lockset assortment that includes a broad selection of designs and finishes—so there's no limit to expressing your style. With proven reliability, ease of installation, and practical features such as 6-in-1 latches and fully reversible levers; now you can confidently infuse your space with a professional look at a smart price.

# PROFESSIONAL SERIES® LOCKSETS

## Provence

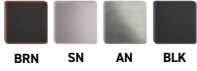

## Bristol

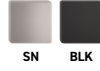

## Hampton



### Notes

Reversible lock

Universal 6-in-1 latches offer a guaranteed fit

Push button auto-release on privacy and function

Includes anti-pry collar for reinforced security

Premium all-metal construction

Fits standard doors 1-3/8" - 1-3/4"



**ANSI GRADE 3**



**FULL KEYING SERVICES AVAILABLE**

WR5 keyway, packaged keyed different



**MEETS ADA STANDARDS**

For levers only



**FIRE RATING AVAILABLE**

Optional 20-minute fire rating. A fire can must be ordered in conjunction with lockset.

### PROVENCE

BOX PACK	ENTRY - KD	PRIVACY	PASSAGE	INSIDE TRIM	DUMMY
AGED BRONZE 10B+	—	—	—	33-HL99	\$59.37 33-991 \$42.52
SATIN NICKEL 15	—	33-D9624AR	\$84.82 33-D9634	\$77.10 33-HL96	\$53.95 33-961 \$38.56
ANTIQUENICKEL 17A	—	—	—	33-HL98	\$53.95 33-981 \$38.56
MATTE BLACK 19	—	—	—	33-HL95BLK	\$53.95 33-951BLK \$38.56
CASE QTY. 20					
VISUAL PACK					
AGED BRONZE 10B+	34-FV9964AR	\$138.00 34-FV9924AR	\$104.75 34-FV9934	\$95.15	— —
SATIN NICKEL 15	34-FV9664AR	\$125.42 34-FV9624AR	\$95.15 34-FV9634	\$86.50	— —
ANTIQUENICKEL 17A	34-FV9864AR	\$125.42 34-FV9824AR	\$95.15 34-FV9834	\$86.50	— —
MATTE BLACK 19	34-FV9564BLKAR	\$125.42 34-FV9524BLKAR	\$95.15 34-FV9534BLK	\$86.50	— —
CASE QTY. 4					

### BRISTOL

\*PLEASE SELECT "R" OR "L" FOR RIGHT OR LEFT HANDING AT END OF ITEM NUMBER WHEN ORDERING INSIDE TRIM & DUMMIES

BOX PACK	PRIVACY	PASSAGE	INSIDE TRIM*	DUMMY*
SATIN NICKEL 15	33-D006024SNRAR	\$84.82 33-D006034SNR	\$77.09 33-HL0060SN__	\$53.99 33-D00604SN__ \$38.56
MATTE BLACK 19	—	—	33-HL0060BLK__	\$53.99 33-D00604BLK__ \$38.56
CASE QTY. 20				
VISUAL PACK				
	ENTRY - KD	PRIVACY	PASSAGE	
SATIN NICKEL 15	34-FV006064SNRAR	\$125.41 34-FV006024SNRAR	\$95.15 34-FV006034SNR	\$86.50 —
MATTE BLACK 19	34-FV006064BKRAR	\$125.41 34-FV006024BKRAR	\$95.15 34-FV006034BLKR	\$86.50 —
CASE QTY. 4				

### HAMPTON

BOX PACK	ENTRY - KA5*	PRIVACY	PASSAGE	INSIDE TRIM	DUMMY
SATIN CHROME 26D	33-D7664AR*	\$104.18 33-D7624AR	\$81.97 33-D7634	\$74.47 33-HL76	\$52.09 33-764 \$37.25
SATIN STAINLESS STEEL 32D	33-D7464AR*	\$93.82 33-D7424AR	\$73.70 33-D7434	\$67.11 33-HL73	\$47.02 33-744 \$33.47
CASE QTY. 20 *ITEM IS KEYED ALIKE IN SETS OF 5 (KA5)					
VISUAL PACK					
	ENTRY - KD	PRIVACY	PASSAGE	INSIDE TRIM	DUMMY
SATIN CHROME 26D	34-FV7664AR	\$106.42 34-FV7624AR	\$85.55 34-FV7634	\$78.02	— —
CASE QTY. 4					

NOTE: NO FIRE RATING AVAILABLE.

**Manchester Dome**



**Villa Ball**

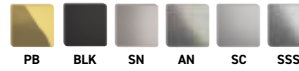

**MANCHESTER DOME**

BOX PACK	ENTRY - KD	PRIVACY	PASSAGE 🔥	INSIDE TRIM	DUMMY
AGED BRONZE 10B+	—	—	—	33-HB36 <b>\$47.89</b>	33-364 <b>\$36.11</b>
SATIN NICKEL 15	—	—	—	33-HB39 <b>\$46.06</b>	33-394 <b>\$32.89</b>
CASE QTY. 20					
VISUAL PACK	ENTRY - KD	PRIVACY	PASSAGE		
AGED BRONZE 10B+	34-FV3614 <b>\$105.67</b>	34-FV3624 <b>\$84.63</b>	34-FV3634 <b>\$79.15</b>	—	—
SATIN NICKEL 15	34-FV3914 <b>\$92.33</b>	34-FV3924 <b>\$73.89</b>	34-FV3934 <b>\$69.37</b>	—	—
CASE QTY. 4					

**VILLA BALL**

BOX PACK	ENTRY - KA5*	PRIVACY	PASSAGE 🔥	INSIDE TRIM	DUMMY
POLISHED BRASS 3	33-D1114 <b>\$56.39</b>	33-D1124 <b>\$44.19</b>	33-D1134 <b>\$41.37</b>	33-HB11 <b>\$28.96</b>	33-114 <b>\$20.68</b>
SATIN NICKEL 15	33-D1014 <b>\$75.23</b>	33-D1024 <b>\$58.86</b>	33-D1034 <b>\$55.09</b>	33-HB10 <b>\$38.52</b>	33-104 <b>\$27.63</b>
MATTE BLACK 19	33-D1214 <b>\$75.23</b>	33-D1224 <b>\$58.86</b>	33-D1234 <b>\$55.09</b>	—	33-124 <b>\$27.63</b>
SATIN CHROME 26D	33-D1314 <b>\$67.69</b>	33-D1324 <b>\$53.02</b>	33-D1334 <b>\$49.47</b>	33-HB13 <b>\$34.78</b>	33-134 <b>\$24.84</b>
LIFETIME FINISH SATIN STAINLESS STEEL 32D	33-D5314 <b>\$56.39</b>	33-D5324 <b>\$44.19</b>	33-D5334 <b>\$41.37</b>	—	33-534 <b>\$20.68</b>
CASE QTY. 20 *ITEM IS KEYPED ALIKE IN SETS OF 5 (KA5)					
VISUAL PACK	ENTRY - KD	PRIVACY	PASSAGE		
POLISHED BRASS 3	34-FV1114 <b>\$59.99</b>	34-FV1124 <b>\$48.71</b>	34-FV1134 <b>\$45.71</b>	—	—
SATIN NICKEL 15	34-FV1014 <b>\$78.78</b>	34-FV1024 <b>\$63.74</b>	34-FV1034 <b>\$59.78</b>	—	—
MATTE BLACK 19	34-FV1214 <b>\$78.78</b>	34-FV1224 <b>\$63.74</b>	34-FV1234 <b>\$59.78</b>	—	—
ANTIQUE NICKEL 17A	34-FV1714 <b>\$78.78</b>	34-FV1724 <b>\$63.74</b>	34-FV1734 <b>\$59.78</b>	—	—
SATIN CHROME 26D	34-FV1314 <b>\$71.27</b>	34-FV1324 <b>\$57.74</b>	34-FV1334 <b>\$54.14</b>	—	—
LIFETIME FINISH SATIN STAINLESS STEEL 32D	34-FV5314 <b>\$62.23</b>	34-FV5324 <b>\$48.71</b>	34-FV5334 <b>\$45.71</b>	—	—
CASE QTY. 4					

**Round Sliding Door Locks**



- › Solid metal
- › Fits standard bore hole 2-1/8" (54 mm)
- › Fixed backset 2-3/8" (60 mm) radius corner latch
- › Push-pull retractable latch
- › Reversible lock
- › Fits standard door thickness

**ROUND SLIDING DOOR LOCKS**

BOX PACK	PRIVACY	PASSAGE
SATIN NICKEL 15	33-SN680RD <b>\$55.86</b>	33-SN690RD <b>\$50.76</b>
MATTE BLACK 19	33-BLK680RD <b>\$55.86</b>	33-BLK690RD <b>\$50.76</b>
POLISHED CHROME 26	33-PC680RD <b>\$55.86</b>	33-PC690RD <b>\$50.76</b>
SATIN CHROME 26D	33-SC680RD <b>\$55.86</b>	33-SC690RD <b>\$50.76</b>
CASE QTY. 30		

**Rectangular Sliding Door Locks**



- › Solid brass construction
- › Fits conventional 1-3/4" x 2-7/8" (45 mm x 73 mm) notch prep
- › Fits standard door thickness

**RECTANGULAR SLIDING DOOR LOCKS**

BOX PACK	PRIVACY	PASSAGE
SATIN NICKEL 15	33-SN580 <b>\$43.44</b>	33-SN590 <b>\$39.47</b>
MATTE BLACK 19	33-BLK580 <b>\$43.44</b>	33-BLK590 <b>\$39.47</b>
POLISHED CHROME 26	33-PC580 <b>\$43.44</b>	33-PC590 <b>\$39.47</b>
SATIN CHROME 26D	33-CH580 <b>\$43.44</b>	33-CH590 <b>\$39.47</b>
CASE QTY. 10		



CENTINEL 3 BLUETOOTH® DIGITAL DEADBOLT SHOWN WITH ARC DECO LEVER

**Centinel 3 Bluetooth® Digital Deadbolt**  **New!**



INTERIOR

**DOWNLOAD  
TAYMOR PROTECT APP**



**SMART DEVICE  
CONTROLLED**



**VACATION  
MODE**



**200 USER  
CODES**



**AUTO LOCK  
UNLOCK OPTIONS**

**Notes**

Bluetooth® connectivity	Event logs	Secure keyless entry convenience	Easily program temporary user codes for guests	Operates on 4 AA batteries, no hardwiring required	Lifetime mechanical and 5 year finish warranty, 1 year electrical components warranty
iOS & Android compatible	Reversible lock				
Operational between temperatures of -35 to 66 C	Universal 6-in-1 latches offer a guaranteed fit	Fully operational via mechanical key		Fits standard door thicknesses	



**ANSI GRADE 2  
COMPLIANT**



**FULL DIGITAL & KEYING  
SERVICES AVAILABLE**

6-pin WR5 keyed different to 5-pin\*



**20 MINUTE FIRE RATED  
WITH MORTISE FACEPLATE**



**MEETS ADA  
STANDARDS**



**UL  
LISTED**

**CENTINEL 3 BLUETOOTH®**

BOX PACK	ENTRY	
SATIN NICKEL 15	33-D5030BLSN	<b>\$555.59</b>
MATTE BLACK 19	33-D5030BLBLK	<b>\$555.59</b>
POLISHED CHROME 26	33-D5030BLPC	<b>\$555.59</b>

CASE QTY. 6

\*SC4 KEYWAY OPTION AVAILABLE



**Centinel 3 Digital Deadbolt** New!



INTERIOR



VACATION  
MODE



10 USER  
CODES



AUTO  
LOCK



CENTINEL 3 DIGITAL DEADBOLT SHOWN WITH FULL BLOOM LEVER



**ANSI GRADE 2  
COMPLIANT**



**FULL KEYING  
SERVICES AVAILABLE**

6-pin WR5 keyed different to 5-pin\*



**20 MINUTE FIRE RATED  
WITH MORTISE FACEPLATE**



MEETS ADA  
STANDARDS



CUL LISTED

**Notes**

Reversible lock

Secure keyless entry  
convenience

Easily program temporary  
user codes for guests

Operates on 4 AA batteries,  
no hardwiring required

Lifetime mechanical and  
5 year finish warranty,  
1 year electrical  
components warranty

Universal 6-in-1 latches  
offer a guaranteed fit

Fully operational via  
mechanical key

Operational between  
temperatures of -35 to 66 C

Fits standard door  
thicknesses 1-3/8" - 1-3/4"

**CENTINEL 3**

BOX PACK

ENTRY

SATIN NICKEL 15

33-D5030SN

**\$421.63**

MATTE BLACK 19

33-D5030BLK

**\$421.63**

POLISHED CHROME 26

33-D5030PC

**\$421.63**

CASE QTY. 6

\*SC4 KEYWAY OPTION AVAILABLE

**Centinel 1**



INTERIOR



**ANSI GRADE 3 COMPLIANT**



**FULL KEYING SERVICES AVAILABLE**

WR5 keyway, packaged keyed different

**Notes**

Reversible lock

Fully operational via  
mechanical key

Operates on 4 AA batteries, no  
hardwiring required

Universal 6-in-1  
latches offer a  
guaranteed fit

Easily program temporary  
user codes for guests

Fits standard door thicknesses

Secure keyless  
entry convenience

Operational between  
temperatures of -35 to 66 C

Lifetime mechanical and 5 year  
finish warranty, 1 year electrical  
components warranty

**CENTINEL 1**

VISUAL PACK

ENTRY

MATTE BLACK 19

34-FV5010BLK

**\$283.79**

SATIN NICKEL 15

34-FV5010SN

**\$283.79**

CASE QTY. 6



VACATION  
MODE



10 USER  
CODES



AUTO  
LOCK

**Concierge 400**



**Simple Setup**  
Easy installation with a Phillips screwdriver



**Vacation Mode**  
Disables all user codes temporarily



**Easy Operation**  
Illuminated 10 digit keypad or touchscreen for easy viewing at night



**Reinforced Security**  
Fingerprint resistant touchscreen & optional code scrambling function

- > Program up to 25 user codes 4-8 digits in length
- > Volume control option to suit your needs
- > Deadbolt fits 2-1/8" (54 mm) or 1-1/2" (38 mm) bore hole
- > Retail friendly full colour box pack

**CONCIERGE 400**

VISUAL PACK	ENTRY
POLISHED BLACK WITH SATIN NICKEL 19/15	33-D5070 <b>\$569.00</b>
CASE QTY. 6	

**Concierge 300**



**FIRE RATING AVAILABLE**

Certified fire rating up to 1.5 hours for Concierge 300

**CONCIERGE 300**

VISUAL PACK	ENTRY
AGED BRONZE 10B+	34-FV4768 <b>\$464.08</b>
SATIN NICKEL 15	34-FV4068 <b>\$421.95</b>
ANTIQUE NICKEL 17A	34-FV4868 <b>\$421.95</b>
MATTE BLACK 19	34-FV5068 <b>\$421.95</b>
SATIN CHROME 26D	34-FV4968 <b>\$421.95</b>
CASE QTY. 4	

- > Program up to 10 user codes 4-6 digits in length
- > Deadbolt fits 2-1/8" (54 mm) or 1-1/2" (38 mm) bore hole

**Notes**

Reversible lock  
Universal 6-in-1 latches offer a guaranteed fit

High tensile steel anti-saw deadbolt

Secure keyless entry convenience

Motorized deadbolt with one-touch locking

Easily program temporary user codes for guests

Master code feature for added security  
Operational between temperatures of -35 to 66 C

Operates on 4 AA batteries, no hardwiring required

Fully operational via conventional key

Fits standard exterior doors

Lifetime mechanical and 5 year finish warranty, 1 year electrical components warranty



**ANSI GRADE 2 COMPLIANT**



**FULL KEYING SERVICES AVAILABLE**

WR5 keyway, packaged keyed different

**Traditional Deadbolt**



INTERIOR

PROFESSIONAL SERIES TRADITIONAL DEADBOLT

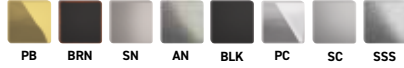

**Notes**

Single or double cylinder available

High security strike

Includes anti-pry collar for reinforced security

Universal 6-in-1 latches offer a guaranteed fit

High tensile steel anti-saw deadbolt with 1" (25 mm) throw

Fits standard exterior doors



**ANSI GRADE 3**



**FULL KEYING SERVICES AVAILABLE**

WR5/SC4 keyway, Visual Pack is keyed different; Combo Set and Box Pack are keyed alike.



**FIRE RATING AVAILABLE**

Optional 20-minute fire rating. A fire can must be ordered in conjunction with a single cylinder deadbolt.

VISUAL PACK	PROFESSIONAL SERIES® SINGLE CYLINDER DEADBOLT - KD / WR5	
POLISHED BRASS 3	34-FV416	<b>\$65.64</b>
AGED BRONZE 10B+	34-FV476	<b>\$90.25</b>
SATIN NICKEL 15	34-FV406	<b>\$81.97</b>
ANTIQUE NICKEL 17A	34-FV486	<b>\$81.97</b>
MATTE BLACK 19	34-FV416BLK	<b>\$81.97</b>
SATIN CHROME 26D	34-FV496	<b>\$81.97</b>
SATIN STAINLESS STEEL 32D	34-FV436	<b>\$65.64</b>
CASE QTY. 4		

BOX PACK	A* - KA3/SINGLE WR5		B* - KA3/SINGLE SC4	
POLISHED BRASS 3	33-D4164	<b>\$67.32</b>	-	
AGED BRONZE 10B+	33-D4764	<b>\$92.53</b>	-	
SATIN NICKEL 15	33-D4064	<b>\$84.06</b>	33-D420	<b>\$92.53</b>
ANTIQUE NICKEL 17A	33-D4864	<b>\$84.06</b>	-	
MATTE BLACK 19	33-D4164BLK	<b>\$84.06</b>	33-D430BLK	<b>\$92.53</b>
POLISHED CHROME 26	33-D4664PC	<b>\$84.06</b>	33-D440PC	<b>\$92.53</b>
SATIN CHROME 26D	33-D4964	<b>\$84.06</b>	33-D470	<b>\$92.53</b>
SATIN STAINLESS STEEL 32D	33-D4364	<b>\$67.32</b>	-	
CASE QTY. 18				

\*A = Professional Series® traditional deadbolt WR5 - 6-in-1 latch - item is keyed alike in sets of 3 (KA3) |

\*B = Professional Series® traditional deadbolt SC4 - 6 pin - 6-in-1 latch - item is keyed alike in sets of 3 (KA3) |

**Combo Pack**

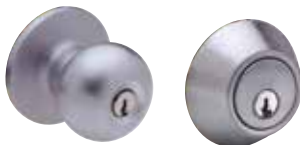

- › Includes single cylinder Professional Series® traditional deadbolt and a Villa entry knob
- › Combo Set is keyed alike

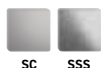

SC SSS

VISUAL PACK	COMBO PACK	
SATIN CHROME 26D	34-FV131496	<b>\$144.04</b>
SATIN STAINLESS STEEL 32D	34-FV531436	<b>\$119.80</b>
CASE QTY. 4		



ASHFORD HANDLESET IN AGED BRONZE



STRAIT HANDLESET IN SATIN CHROME

**Notes**

Compatible with all Taymor Premier and Professional Series® locksets for interior trim

For customization options see pg. 120

Universal 6-in-1 latches offer a guaranteed fit

Premium all-metal construction

Fits standard exterior doors

Coordinates with a broad array of Taymor exterior hardware



**ANSI GRADE 3**



**FULL KEYING SERVICES AVAILABLE**

WR5 keyway, packaged keyed different



**FIRE RATING AVAILABLE**

Optional 20-minute fire rating. A fire can must be ordered in conjunction with lockset.



**EXTENSION KIT AVAILABLE**

Optional Extension Kit works to accommodate doors that are 2-1/4" thick. (see pg. 118).

**Strait**



> Deadbolt fits 2-1/8" (54 mm) or 1-1/2" (38 mm) bore hole

**Ashford**



> Deadbolt fits standard bore hole 2-1/8" (54 mm)

**Madera**



> Deadbolt fits 2-1/8" (54mm) or 1-1/2" (38mm) bore hole

	STRAIT SQUARE ROSE - BOX PACK		STRAIT ROUND ROSE - VISUAL PACK		ASHFORD VISUAL PACK	
AGED BRONZE 10B+	—	—	—	—	34-FV0477	\$473.30
SATIN NICKEL 15	33-0766	\$343.92	34-FV0766	\$337.51	34-FV0467	\$435.69
MATTE BLACK 19	33-0782*	\$343.92	—	—	34-FV0482	\$435.69
POLISHED CHROME 26	33-0726	\$343.92	34-FV0726	\$337.55	—	—
SATIN CHROME 26D	33-0746	\$343.92	—	—	—	—
CASE QTY. 6						

\*WITH VEGA SQUARE ROSE LEVER TRIM

	MADERA* BOX PACK		MADERA VISUAL PACK	
POLISHED BRASS 3	—	—	34-FV8110	\$266.07
SATIN NICKEL 15	33-D8054KD	\$372.33	34-FV8050	\$322.66
ANTIQUE NICKEL 17A	—	—	34-FV8170	\$322.66
MATTE BLACK 19	—	—	34-FV8110BLK	\$322.66
BOX PACK CASE QTY. 10 / VISUAL PACK CASE QTY. 6				

\*Solid brass

# BUILDERS SERIES

## Silver Moon



GRADE  
**3**

**ANSI GRADE 3**

### Notes

Reversible lever handing (excluding Orleans in dummy function)

## Perspective

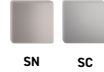

**FULL KEYING SERVICES AVAILABLE**

WR5 keyway, packaged keyed different.

Universal 4-1 latches with adjustable backset (2-3/8" and 2-3/4")

Fits standard doors 1-3/8" - 1-3/4"

## Orleans



**FIRE RATING AVAILABLE**

Optional 20-minute fire rating. A UL latch must be ordered in conjunction with lockset.



Silver Moon and Perspective levers meet ADA standards with push button auto-release on privacy and entry functions in Silver Moon and Perspective levers

## Basic Ball

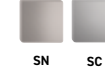

### SILVER MOON

BOX PACK	ENTRY - KD	PRIVACY	PASSAGE	DUMMY
SATIN NICKEL 15	36-D7510SN <b>\$91.37</b>	36-D7503SN <b>\$77.27</b>	36-D7505SN <b>\$70.31</b>	36-7511SN <b>\$35.17</b>
POLISHED CHROME 26	36-D7510PC <b>\$91.37</b>	36-D7503PC <b>\$77.27</b>	36-D7505PC <b>\$70.31</b>	36-7511PC <b>\$35.17</b>
SATIN CHROME 26D	36-D7510SC <b>\$91.37</b>	36-D7503SC <b>\$77.27</b>	36-D7505SC <b>\$70.31</b>	36-7511SC <b>\$35.17</b>
CASE QTY. 20				

### PERSPECTIVE

BOX PACK	ENTRY - KD	PRIVACY	PASSAGE	DUMMY
SATIN NICKEL 15	36-D6210SN <b>\$75.51</b>	36-D6203SN <b>\$59.52</b>	36-D6205SN <b>\$54.06</b>	36-6211SN <b>\$27.11</b>
SATIN CHROME 26D	36-D6210SC <b>\$75.51</b>	36-D6203SC <b>\$59.52</b>	36-D6205SC <b>\$54.06</b>	36-6211SC <b>\$27.11</b>
CASE QTY. 20				

### ORLEANS

\*PLEASE SELECT "R" OR "L" FOR RIGHT OR LEFT HANDING AT END OF ITEM NUMBER WHEN ORDERING DUMMIES

BOX PACK	ENTRY - KD	PRIVACY	PASSAGE	DUMMY*
AGED BRONZE 10B+	36-D8310CBRN <b>\$98.34</b>	36-D8303BBRN <b>\$77.48</b>	36-D8305BRN <b>\$70.51</b>	36-8311__BRN <b>\$35.35</b>
SATIN NICKEL 15	36-D8310CSN <b>\$89.33</b>	36-D8303BSN <b>\$70.51</b>	36-D8305SN <b>\$64.13</b>	36-8311__SN <b>\$31.96</b>
CASE QTY. 20				

### BASIC BALL

BOX PACK	ENTRY - KD	PRIVACY	PASSAGE	DUMMY
SATIN NICKEL 15	36-D4210SN <b>\$49.76</b>	36-D4203SN <b>\$39.41</b>	36-D4205SN <b>\$36.87</b>	36-4211SN <b>\$18.33</b>
SATIN CHROME 26D	36-D4210SC <b>\$49.76</b>	36-D4203SC <b>\$39.41</b>	36-D4205SC <b>\$36.87</b>	36-4211SC <b>\$18.33</b>
CASE QTY. 20				

## Builder Series Traditional Deadbolt

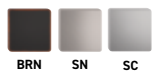

### Notes

Single cylinder Adjustable 4-in-1 latch with high security/regular strike available

High tensile steel anti-saw deadbolt with 1" (25 mm) throw

Fits standard doors 1-3/8" - 1-3/4"



**FULL KEYING SERVICES AVAILABLE**

WR5 keyway, packaged keyed alike - KA3.



**FIRE RATING AVAILABLE**

Optional 20-minute fire rating. A UL latch must be ordered in conjunction with deadbolt.

### BUILDER SERIES TRADITIONAL DEADBOLT

BOX PACK	4-IN-1 LATCH WITH HIGH SECURITY STRIKE - KA3	4-IN-1 LATCH WITH REGULAR STRIKE - KA3
AGED BRONZE 10B+	36-D104HSBRN <b>\$44.20</b>	—
SATIN NICKEL 15	36-D104HSSN <b>\$40.24</b>	36-D104SN <b>\$37.79</b>
SATIN CHROME 26D	36-D104HSSC <b>\$40.24</b>	36-D104SC <b>\$37.79</b>
CASE QTY. 30		

## Notes

Reversible lock

Resealable clamshell packaging

All-metal construction

Fits standard doors  
1-3/8" - 1-3/4"

Adjustable 4-in-1 latch

GRADE  
3

**ANSI GRADE 3**



WR5 keyway, packaged keyed different. Combo Packs are keyed alike.



**NON-FIRE RATED**

### AXIA LEVER

VISUAL PACK	ENTRY - KD	PRICE	PRIVACY	PRICE	PASSAGE	PRICE
SATIN NICKEL 15	35-CV2610CSN	<b>\$73.56</b>	35-CV2603BSN	<b>\$58.94</b>	35-CV2605SN	<b>\$53.48</b>
CASE QTY. 12						

### STRAIGHT LEVER

VISUAL PACK	ENTRY - KD	PRICE	PRIVACY	PRICE	PASSAGE	PRICE
SATIN NICKEL 15	35-CV4310	<b>\$58.94</b>	35-CV4303B	<b>\$49.97</b>	35-CV4305	<b>\$45.27</b>
CASE QTY. 12						

### ARC LEVER

VISUAL PACK	ENTRY - KD	PRICE	PRIVACY	PRICE	PASSAGE	PRICE
SATIN NICKEL 15	35-CV3610C	<b>\$58.94</b>	35-CV3603B	<b>\$52.32</b>	35-CV3605	<b>\$48.77</b>
CASE QTY. 12						

### BALL KNOB

VISUAL PACK	ENTRY - KD	PRICE	PRIVACY	PRICE	PASSAGE	PRICE
POLISHED BRASS 3	35-CV1410C	<b>\$38.83</b>	35-CV1403B	<b>\$35.72</b>	35-CV1405	<b>\$33.37</b>
SATIN STAINLESS STEEL 32D	35-CV1110C	<b>\$38.83</b>	35-CV1103B	<b>\$35.72</b>	35-CV1105	<b>\$33.37</b>
CASE QTY. 24						

### HANDLESET

VISUAL PACK	ENTRY - KD	PRICE
SATIN NICKEL 15	35-CV6595	<b>\$172.91</b>
CASE QTY. 6		

### DEADBOLT

VISUAL PACK - KD	SINGLE CYLINDER DEADBOLT	PRICE
POLISHED BRASS 3	35-V216PB	<b>\$35.13</b>
SATIN NICKEL 15	35-V216SN	<b>\$43.32</b>
SATIN STAINLESS STEEL 32D	35-V216SS	<b>\$35.13</b>
CASE QTY. 24		

### COMBO PACKS

VISUAL PACK - KA	ENTRY KNOB & DEADBOLT COMBO	PRICE	ENTRY KNOB TWIN PACK	PRICE
SATIN STAINLESS STEEL 32D	35-CV1116	<b>\$74.52</b>	35-TPV1110C	<b>\$73.77</b>
CASE QTY. 12				

NOTE: NO FIRE RATING AVAILABLE.



AXIA LEVER



SN



STRAIGHT LEVER



SN



ARC LEVER



SN



BALL KNOB

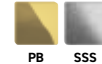

PB SSS



DEADBOLT



PB SN SSS



HANDLESET



SN



# Pro/Key Program



## Keyway Options

Available in a Weiser WR5 5-pin keyway:

- Professional Series
- Builder Series - Orleans Lever and Gala Ball Knob
- Epic Series
- Premier Visual Pack Deadbolts

Available in a Schlage SC4 6-pin keyway:

- Premier Series
- Interconnected Locks
- Mortise Locks
- Professional Series Deadbolts
- Builder Series - Deadbolts and Perspective and Silver Moon Levers
- Commercial Locks (WR5 keyway available on request)

## Keying Options

ALSO SEE FACING PAGE FOR COMMON KEYING OPTIONS >

Combination of Master & Construction Keying

Combination of Master & Double Knockout Construction Keying

Combination of Grand Master & Construction Keying

Combination of Grand Master & Double Knockout Construction Keying

Customer Specific Keying Available

## Additional Services

Custom logo keys

Custom escutcheon etching

Custom key stamping and cylinder marking

Minimum quantities and lead times apply. Please contact Taymor for details.



# Keying Options

**KEYED ALIKE (KA)** systems are a perfect solution for single-family homes where homeowners may want one key to open multiple locks; for example, the front entrance and the back door.

**KEYED DIFFERENT (KD)** systems are common in multi-family buildings where each unit opens with a unique key.

**MASTER KEYING (MK)** systems are common in multi-family, commercial and institutional buildings where multiple levels of building access are required. Individual units each have a unique key and the master key permits access to all units for maintenance, and management staff as well as first responders.

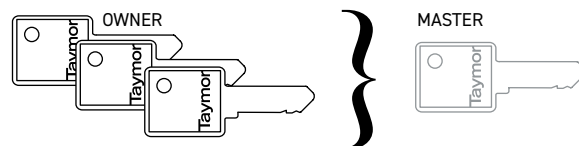

**GRAND MASTER KEYING (GMK)** allows the owner or strata responsible for multiple buildings to have one grand master key that operates all locks. Individual units have a unique key while each building has a master key that permits access to all areas—or to targeted areas—for tenants, maintenance, and management staff as well as first responders.

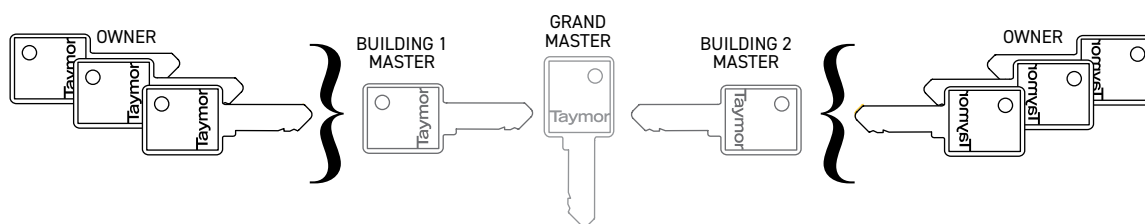

**CONSTRUCTION KEYING (CK)** allows the contractor of a project full access during the construction period. Once the owner's key is inserted, operation by the initial construction key is permanently disabled.

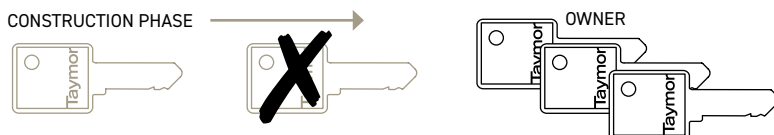

**DOUBLE KNOCKOUT CONSTRUCTION KEYING (CKRK)** adds a realtor key between the construction key and the owner key, which essentially allows a real estate professional to get temporary access until final handover to the buyer occurs. Once the owner's key is inserted, operation by the realtor key is permanently disabled.

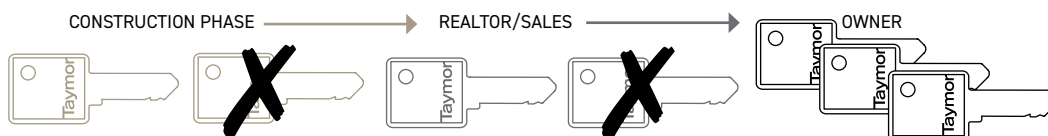





## Exterior Hardware

Whether you're looking to add efficiency or wanting to make a great first impression, Taymor exterior hardware allows you to personalize your look and enhance the curb appeal of your home.



## 6" Backlit LED House Numbers

- › Warm bright light appearance: 3,200K
- › Durable, weather-resistant matte black metal
- › Connect up to 5 Backlit LED House Numbers
- › House numbers are pin mounted about 1/4-inches (6.5 mm) from the wall surface for a floating effect and no visible hardware
- › Mounting hardware and installation template included
- › Optional light sensor accessory turns numbers on/off automatically (sold separately)
- › Required power adaptor is rated for indoor use only, comes with 6 ft. (1.83 m) cord and installation instructions (sold separately)

When ordering, add desired address – numerals 0 through 9 – to the end of the SKU. For example: 27-MSN4( )



### OPERATION TEMPERATURE

-30° to +40°C (-22°F to 104°F) (Temperature tolerance could vary due to different weather conditions)



## 6" BACKLIT LED HOUSE NUMBERS

	6" (152 mm)
HOUSE NUMBERS - BLACK FINISH	25-LEDF6__ \$113.12
POWER SUPPLY (REQUIRED)	25-LEDFPWR \$ 72.76
LIGHT SENSOR (OPTIONAL)	25-LEDPHOTO \$ 46.37
CASE QTY. 4 PKG. VISUAL PACK	

Designer | Solid Metal

0123456789

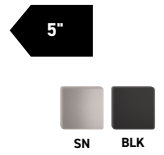

- › Easy to install
- › UV coating for long lasting finish
- › Flush mount or pin-mount for a floating effect
- › Concealed screw mount
- › Mounting hardware includes wall spacers and template



	5" (127 mm)	
SATIN NICKEL 15	25-DSN5__	\$26.03
MATTE BLACK 19	25-DBLK5__	\$26.03
CASE QTY. 4	PKG. CARDED	

Modern | Solid Metal

0123456789

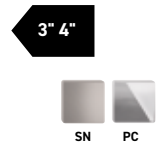

- › Easy to install
- › Flush mount or pin-mount for a floating effect
- › Concealed screw mount
- › Mounting hardware included

	3" (76 mm)		4" (102 mm)	
SATIN NICKEL 15	27-MSN3__	\$11.50	27-MSN4__	\$16.28
POLISHED CHROME 26	27-MPC3__	\$11.50	-	-
CASE QTY. 5	PKG. POLY BAGGED		PKG. CARDED	

Classic | Solid Metal

0123456789

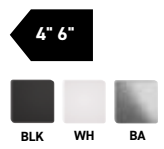

- › Easy to install
- › Mounting hardware included

	4" (102 mm)		6" (152 mm)	
BLACK	25-ANB4__	\$7.94	25-ANB6__	\$14.57
WHITE	-	-	25-ANW6__	\$14.57
BRUSHED ALUMINUM	25-ANC4__	\$7.94	25-ANC6__	\$14.57
PKG. CARDED	CASE QTY. 10		CASE QTY. 5	

Oval Easy Install Plaque



- › Easy-install address plaque in a timeless oval design
- › White reflective background
- › Allows up to 4 house numbers
- › Black vinyl house numbers

Contemporary Easy Install Plaque



- › Easy-install address plaque in a timeless clean design
- › White reflective background
- › Allows up to 4 house numbers
- › Black vinyl house numbers

Notes

Durable, weather-resistant	36 durable self-adhesive 4-inch (102 mm) vinyl house numbers included	Mounting hardware, templates and easy-to-follow installation instructions included
----------------------------	---	--

	OVAL	CONTEMPORARY
DIMENSIONS W x H x D	15-3/4" x 9-1/16" x 3/4" (400 mm x 230 mm x 19 mm)	12-3/4" x 6-9/16" x 1" (325 mm x 167 mm x 26 mm)
EASY INSTALL ADDRESS PLAQUES	25-9430 <b>\$72.72</b>	25-9440 <b>\$58.59</b>
CASE QTY. 4 PKG. VISUAL PACK		



MODERN DOOR KNOCKER IN MATTE BLACK



CLASSIC DOOR KNOCKER IN SATIN NICKEL

**Modern**



› Concealed screw mount

**Classic**



› Exposed screw mount

**Notes**

Solid Metal Construction

Weather-resistant

Easy to install

Strike, mounting hardware and template included

	MODERN	CLASSIC
DIMENSIONS W x H	2-1/4" x 5-1/2" (57 mm x 140 mm)	3-3/16" x 6-5/16" (81 mm x 161 mm)
POLISHED BRASS 3	—	25-D4809B <b>\$30.95</b>
SATIN NICKEL 15	25-D4810SN <b>\$35.92</b>	25-D4809SN <b>\$30.95</b>
BLACK 19	25-D4810BLK <b>\$35.92</b>	25-D4809 <b>\$30.95</b>
PKG. CARDED	CASE QTY. 5	CASE QTY. 5



180° FIRE RATED VIEWER WITH MODERN DOOR KNOCKER IN SATIN NICKEL

### 160° Fire Rated 20 min.

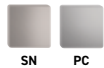

- › Bore size 1/2" (12 mm)
- › Adjustable from 1-3/8" to 2" (35 mm to 50 mm)
- › 160° field of vision
- › Solid brass body



### 180° Fire Rated 20 min.



- › Bore size 9/16" (14 mm)
- › Adjustable from 1-3/8" to 2" (35 mm to 50 mm)
- › 180° field of vision
- › Solid brass body



### 180°

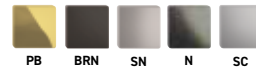

- › Bore size 9/16" (14 mm)
- › Adjustable from 1-3/8" to 2-1/4" (35 mm to 57 mm)
- › 180° field of vision
- › Zinc diecast construction

	160° FIRE RATED 20 MIN.		180° FIRE RATED 20 MIN.		180°	
POLISHED BRASS 3	—	—	—	—	25-D4846B	<b>\$13.23</b>
OIL RUBBED BRONZE 10B	—	—	—	—	25-D4846ORB	<b>\$14.56</b>
SATIN NICKEL 15	37-4820SN	<b>\$16.05</b>	37-4825SN	<b>\$18.95</b>	25-D4846SN	<b>\$13.23</b>
NICKEL 26	—	—	—	—	25-D4846N	<b>\$13.23</b>
MATTE BLACK 19	—	—	37-4825BLK	<b>\$18.95</b>	—	—
POLISHED CHROME 26	37-4820	<b>\$16.05</b>	37-4825	<b>\$18.95</b>	—	—
SATIN CHROME 26D	—	—	—	—	25-D4846SC	<b>\$13.23</b>
CASE QTY.	25		25		10	
PKG.	INDIVIDUAL BOX		INDIVIDUAL BOX		CARDED	





KICK PLATE IN SATIN ALUMINUM

## Kick Plates

### Notes

Provides a decorative accent to your door while protecting the door surface	Pre-drilled holes for easy installation	0.038 inch (0.097 mm) gauge aluminum	Weather-resistant and easy to clean	Easy-to-follow installation instructions	Includes self-tapping screws, suitable for metal or wood doors, in matching finish
---	---	--------------------------------------	-------------------------------------	--	--

DIMENSIONS W x H	30" x 6" (76.2 cm x 15.2 cm)	32" x 6" (81.3 cm x 15.2 cm)	34" x 8" (86.4 cm x 20.3 cm)
SATIN ALUMINUM	—	25-D632 <b>\$77.76</b>	25-D834 <b>\$103.95</b>
POLISHED BRASS 3	25-DA630 <b>\$71.32</b>	—	25-DA834 <b>\$103.95</b>
OIL RUBBED BRONZE 10B	—	—	25-D834ORB <b>\$103.95</b>
SATIN NICKEL 15	—	—	25-D834SN <b>\$103.95</b>

CASE QTY. 5 PKG. INDIVIDUAL COLOR BOX



METRA & BARCELONA CLOSET KNOBS

# Interior Hardware

## 8000 Series Plain Bearing Residential Butt Hinge



1/4" RADIUS



5/8" RADIUS

- > Includes #8 type 3/4" (19 mm) screws for 3" x 3" (76 mm x 76 mm) & 3-1/2" x 3-1/2" (89 mm x 89 mm) hinge size
- > Includes #9 type 3/4" (19 mm) screws for 4" x 4" (102 mm x 102 mm) hinge size

### 1/4" Radius

VISUAL PACK - PAIRS	3" x 3" (76 mm x 76 mm)		3-1/2" x 3-1/2" (89 mm x 89 mm)		4" x 4" (102 mm x 102 mm)	
THICKNESS	2.0 mm		2.2 mm		2.5 mm	
POLISHED BRASS 3	25-PK8945A	\$6.37	-		-	
OIL RUBBED BRONZE 10B	25-PK8545A	\$6.90	25-PK8545B	\$8.79	-	
SATIN NICKEL 15	25-PK8245A	\$6.37	25-PK8245B	\$8.19	25-PK8245C	\$10.61
ANTIQUE NICKEL 17A	25-PK8145A	\$6.37	-		-	
MATTE BLACK 19	25-PKBLK8545A	\$6.37	25-PKBLK8545B	\$8.19	-	
SATIN CHROME 26D	25-PK8345A	\$6.37	25-PK8345B	\$8.19	-	
CASE QTY.	50		50		25	

BULK PACK - PAIRS SOLD BY CASE QTY. ONLY	3" x 3" (76 mm x 76 mm) assembled		3-1/2" x 3-1/2" (89 mm x 89 mm) assembled		4" x 4" (102 mm x 102 mm) non removable pin	
THICKNESS	2.0 mm		2.2 mm		2.5 mm	
SATIN NICKEL 15	25-8245A	\$5.80	25-8245B	\$ 6.85	25-NP8245C	\$12.27
FINE POLISHED CHROME 26	-		25-8645B	\$12.30	-	
SATIN CHROME 26D	-		25-8345B	\$ 6.85	-	
CASE QTY.	50		50		25	

### 5/8" Radius

VISUAL PACK - PAIRS	3" x 3" (76 mm x 76 mm)		3-1/2" x 3-1/2" (89 mm x 89 mm)	
THICKNESS	2.0 mm		2.2 mm	
POLISHED BRASS 3	25-PK8946A	\$ 6.37	-	
OIL RUBBED BRONZE 10B	25-PK8546A	\$ 6.90	25-PK8546B	\$8.79
SATIN NICKEL 15	25-PK8246A	\$ 6.37	25-PK8246B	\$8.19
MATTE BLACK 19	25-PKBLK8546A	\$ 6.37	25-PKBLK8546B	\$8.19
FINE POLISHED CHROME 26	25-PK8646A	\$12.30	-	
SATIN CHROME 26D	25-PK8346A	\$ 6.37	25-PK8346B	\$8.19
CASE QTY.	50		50	

5/8" Radius

BULK PACK - PAIRS SOLD BY CASE QTY. ONLY	3" x 3" assembled (76 mm x 76 mm)		3" x 3" unassembled (76 mm x 76 mm)		3-1/2" x 3-1/2" assembled (89 mm x 89 mm)	
THICKNESS	2.0 mm		2.0 mm		2.2 mm	
OIL RUBBED BRONZE 10B	—	—	25-8558AKD	<b>\$6.82</b>	25-8546B	<b>\$ 8.79</b>
SATIN NICKEL 15	25-8246A	<b>\$5.80</b>	25-8258AKD	<b>\$6.42</b>	25-8246B	<b>\$ 6.85</b>
ANTIQUE NICKEL 17A	25-8146A	<b>\$5.80</b>	25-8158AKD	<b>\$6.42</b>	—	—
MATTE BLACK 19	—	—	25-BLK8558AKD	<b>\$6.42</b>	—	—
FINE POLISHED CHROME 26	—	—	—	—	25-8646B	<b>\$12.30</b>
SATIN CHROME 26D	25-8346A	<b>\$5.80</b>	—	—	25-8346B	<b>\$ 6.85</b>
CASE QTY.	50	—	50	—	50	—

Square Corner

VISUAL PACK - PAIRS	3" x 3" (76 mm x 76 mm)		3-1/2" x 3-1/2" (89 mm x 89 mm)		4" x 4" (102 mm x 102 mm)	
THICKNESS	2.0 mm		2.2 mm		2.5 mm	
POLISHED BRASS 3	25-PK8944A	<b>\$ 6.37</b>	—	—	—	—
OIL RUBBED BRONZE 10B	25-PK8544A	<b>\$ 6.90</b>	—	—	—	—
SATIN NICKEL 15	25-PK8244A	<b>\$ 6.37</b>	25-PK8244B	<b>\$8.19</b>	25-PK8244C	<b>\$10.61</b>
ANTIQUE NICKEL 17A	25-PK8144A	<b>\$ 6.37</b>	—	—	—	—
MATTE BLACK 19	25-PKBLK8544A	<b>\$ 6.37</b>	—	—	—	—
FINE POLISHED CHROME 26	25-PK8644A	<b>\$12.30</b>	—	—	—	—
SATIN CHROME 26D	25-PK8344A	<b>\$ 6.37</b>	—	—	—	—
CASE QTY.	50	—	50	—	25	—



SQUARE CORNER

3300 Series Single Action Spring Hinges



- › Conforms to ANSI specifications
- › Easily adjusted spring tension
- › One hinge per box

New Finish  
Coming Soon!



SQUARE CORNER

4" x 4" (102 mm x 102 mm) Single Action

VISUAL PACK - EACH	SQUARE CORNER	
THICKNESS	2.5 mm	
SATIN CHROME 26D	25-3310DCC	<b>\$35.35</b>
CASE QTY. 40	—	

4-1/2" x 4" (114 mm x 102 mm) Single Action

VISUAL PACK - EACH	SQUARE CORNER	
THICKNESS	3.4 mm	
SATIN NICKEL 15	25-3310ND	<b>\$49.46</b>
MATTE BLACK 19 <b>New!</b>	25-3310BLKD	<b>\$49.46</b>
SATIN CHROME 26D	25-3310DCD	<b>\$49.46</b>
CASE QTY. 40	—	

4100 Series Commercial Template Butt Hinges

- › 3 pieces (1-1/2 pairs) per set; 1 set packaged per box
- › Includes machine and wood screws
- › Conforms to ANSI specifications



A.

B.

C.

New Finish  
Coming Soon!

SIZE: 4-1/2" x 4" (114 mm x 102 mm) THICKNESS: 3.4 mm	SATIN NICKEL 15		MATTE BLACK 19		SATIN CHROME 26D	
A. Plain bearing butt hinges	25-4169N	<b>\$36.63</b>	—	—	—	—
B. Ball bearing butt hinges*	25-4172N	<b>\$50.85</b>	—	—	25-4172DC	<b>\$50.85</b>
C. Non-removable pin ball bearing butt hinges*	25-4173N	<b>\$60.86</b>	25-4173BLK	<b>\$60.86</b>	25-4173DC	<b>\$60.86</b>

CASE QTY. 16 PKG. BOX PACKAGING \* Ball bearing hinges must be used in conjunction with a door closer on all fire-rated openings.

## INTERIOR HARDWARE DOOR STOPS

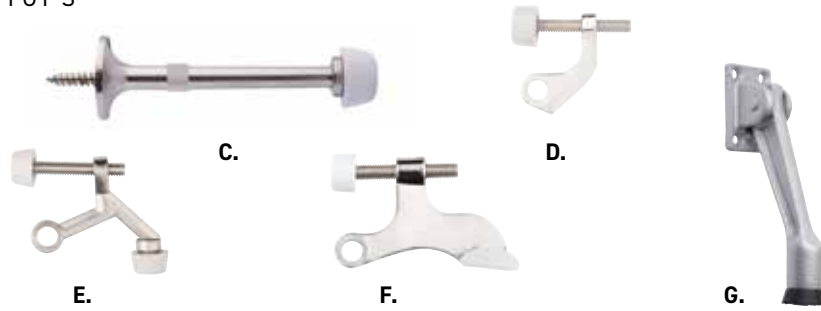
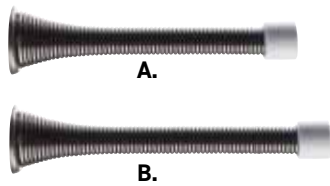

### A. & B. Spring Door Stops

- › Steel spring wire

	A. 3-1/8" (79 mm)		A. 3-1/8" (79 mm)		B. 3-3/4" (95 mm)
POLISHED BRASS 3	25-4671B	\$1.46	25-P4671B	\$1.73	—
OIL RUBBED BRONZE 10B	25-4671ORB	\$1.58	25-P4671ORB	\$1.90	—
SATIN NICKEL 15	25-4671SN	\$1.46	25-P4671SN	\$1.73	25-4674SN \$2.15
NICKEL 26	25-4671N	\$1.46	25-P4671N	\$1.73	25-4674N \$2.15
ANTIQUE NICKEL 17A	—	—	25-P4671AN	\$1.73	—
MATTE BLACK 19	25-4671BLK	\$1.58	25-P4671BLK	\$1.73	—
SATIN CHROME 26D	25-4671SC	\$1.46	25-P4671SC	\$1.73	25-4674SC \$2.15
CASE QTY.	50 (BB50)		50 (PB)		50 (BB50)

PKG BB50 = BULK, BAGS OF 50, PB = POLY BAGGED WITH UPC

### C. Solid Door Stop

- › Zinc diecast construction

	C. 2-7/8" (73 mm)	
SATIN NICKEL 15	25-P4679SN	\$3.27
MATTE BLACK 19	25-P4679BLK	\$3.27
NICKEL 26	25-P4679N	\$3.27
SATIN CHROME 26D	25-P4679SC	\$3.27
CASE QTY. 50 PKG. POLY BAGGED WITH UPC		

### D. Door Saver Hinge Pin Door Stop

- › Adjustable door opening angle
- › Zinc diecast construction
- › Does not touch the door

	D.	
SATIN NICKEL 15	25-B4614SPSN	\$7.95
POLISHED CHROME 26	25-B4614SPPC	\$7.95
CASE QTY. 50 PKG. POLY BAGGED WITH UPC		

### E. Hinge Pin Door Stop

- › Adjustable door opening angle
- › Zinc diecast construction

	E.		F.	
POLISHED BRASS 3	—	—	25-P4634B	\$5.72
AGED BRONZE 10B+	—	—	25-P4634ORB	\$6.22
SATIN NICKEL 15	25-P4614SN	\$3.48	25-P4634SN	\$5.72
NICKEL 26	25-P4614N	\$3.48	25-P4634N	\$5.72
ANTIQUE NICKEL 17A	—	—	25-P4634AN	\$5.72
MATTE BLACK 19	25-P4614BLK	\$3.48	25-P4634BLK	\$5.72
SATIN CHROME 26D	25-P4614SC	\$3.48	25-P4634SC	\$5.72
CASE QTY.	50 (PB)		20 (PB)	
PKG. POLY BAGGED WITH UPC				

### F. Wide Angle Hinge Pin Door Stop

- › Adjustable door opening angle
- › Adjustable shoe
- › Zinc diecast construction

	G. 5-5/8" (143 mm)		REPLACEMENT RUBBER TIP	
SILVER FINISH	25-4650SR	\$21.18	25-R4650T	\$4.66
CASE QTY. 10 PKG. POLY BAGGED WITH UPC			CASE QTY. 50 PKG. BULK PACK	

### G. Elephant Door Stop

- › Cast iron
- › Includes mounting screws

## Floor & Wall Stops

- › Includes screw, expansion shield and rubber bumper
- › Metal construction



	SATIN NICKEL 15		SATIN CHROME 26D		ALUMINUM 28	CASE QTY.
A. Floor stops - 1" (25 mm) low profile	25-4609DN	\$8.91	25-4609DC	\$ 8.91	—	10
B. Floor stops - 1-3/8" (35 mm) high profile	25-4610DN	\$9.26	25-4610DC	\$9.26	—	10
C. 1/4" (6 mm) Riser for 25-4609 & 25-4610	—	—	—	—	25-4608AL	\$5.72 25
D. Wall stops - Convex	—	—	25-4611DC	\$12.82	—	10
E. Wall stops - Concave	25-4612DN	\$11.39	25-4612DC	\$11.39	—	10

PKG. POLY BAGGED WITH UPC

**Barcelona Knob**

- > Zinc diecast construction
- > 1-1/16" (27 mm) round diameter
- > Includes 1-13/16" (46 mm) break-off screw



SATIN NICKEL 15	20-0810SN	<b>\$10.59</b>
MATTE BLACK 19	20-0810BLK	<b>\$10.59</b>
POLISHED CHROME 26	20-0810PC	<b>\$10.59</b>
SATIN CHROME 26D	20-0810SC	<b>\$10.59</b>
CASE QTY. 20 PKG. POLY BAGGED WITH UPC		

**Metra Knob**

- > Zinc diecast construction
- > 1" (25 mm) width
- > Includes two 1-13/16" (46 mm) break-off screws



SATIN NICKEL 15	20-0700SN	<b>\$9.26</b>
MATTE BLACK 19	20-0700BLK	<b>\$9.26</b>
POLISHED CHROME 26	20-0700PC	<b>\$9.26</b>
CASE QTY. 20 PKG. POLY BAGGED WITH UPC		

**Pedestal Knob with Removable Back Plate**

- > Zinc diecast construction
- > 1-1/4" (32 mm) diameter
- > 1-11/16" (43 mm) back plate
- > Includes 2" (51 mm) break-off screw



AGED BRONZE 10B+	20-B10500RB	<b>\$10.53</b>
SATIN NICKEL 15	20-B1050SN	<b>\$9.58</b>
SATIN CHROME 26D	20-B1050SC	<b>\$9.58</b>
CASE QTY. 25 PKG. POLY BAGGED WITH UPC		

**Classic Knob**

- > Zinc diecast construction
- > 1-3/16" (30 mm) diameter
- > Includes 2" (51 mm) break-off screw



SATIN NICKEL 15	20-0388SN	<b>\$7.54</b>
MATTE BLACK 19	20-0388BLK	<b>\$7.54</b>
POLISHED CHROME 26	20-0388CH	<b>\$7.54</b>
SATIN CHROME 26D	20-0388SC	<b>\$7.54</b>

CASE QTY. 25 PKG. POLY BAGGED WITH UPC

**Modern Knob**

- > Zinc diecast construction
- > 5/8" (16 mm) diameter
- > Includes 1-7/8" (47 mm) break-off screw



SATIN NICKEL 15	20-0380SN	<b>\$5.46</b>
MATTE BLACK 19	20-0380BLK	<b>\$5.46</b>
POLISHED CHROME 26	20-0380PC	<b>\$5.46</b>
CASE QTY. 20 PKG. POLY BAGGED WITH UPC		

## INTERIOR HARDWARE CLOSET & CABINET

### Fixed Heavy Duty Shelf & Rod Support

- › For shelf up to 12" (305 mm) wide and rod up to 1-1/2" (38 mm) diameter
- › Steel construction
- › Includes mounting screws

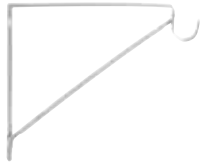

WHITE ENAMEL	25-2810	<b>\$7.90</b>
CASE QTY. 20 PKG. UPC LABEL		

### Fixed Heavy Duty Shelf Support Only

- › For shelf up to 12" (305 mm) wide
- › Steel construction
- › Includes mounting screws



WHITE ENAMEL	25-2815	<b>\$7.55</b>
CASE QTY. 20 PKG. UPC LABEL		

### Adjustable Steel Closet Rod

- › Steel construction
- › 1" (25 mm) diameter rod
- › Includes mounting screws



	18" - 30" (45.7 cm - 76.2 cm)	30" - 48" (76.2 cm - 121.9 cm)	48" - 72" (121.9 cm - 182.9 cm)	72" - 96" (182.9 cm - 243.8 cm)	96" - 120" (243.8 cm - 304.8 cm)
STEEL	25-MR1830 <b>\$7.18</b>	25-MR3048 <b>\$10.56</b>	25-MR4872 <b>\$14.63</b>	25-MR7296 <b>\$18.94</b>	25-MR96120 <b>\$24.15</b>
WHITE ENAMEL	25-MR1830W <b>\$8.28</b>	25-MR3048W <b>\$11.54</b>	25-MR4872W <b>\$16.15</b>	25-MR7296W <b>\$21.08</b>	25-MR96120W <b>\$26.93</b>
CASE QTY. 10 PKG. POLY BAGGED WITH UPC					

### Round Door Pulls



- › Steel construction
- › For use on sliding doors and panels
- › Pressure fit
- › 2-1/8" (54 mm) diameter, 1/4" (7 mm) deep

ROUND			SQUARE	
SATIN NICKEL 15	20-L2900SN	<b>\$2.64</b>	20-L3000SN	<b>\$7.41</b>
MATTE BLACK 19	20-L2900BLK	<b>\$2.64</b>	20-L3000BLK	<b>\$7.41</b>
POLISHED CHROME 26	25-L2900PC	<b>\$2.64</b>	20-L3000PC	<b>\$7.41</b>
SATIN CHROME 26D	20-L2900SC	<b>\$2.64</b>	-	-
PKG. POLY BAGGED WITH UPC			CASE QTY. 150	CASE QTY. 50

### Square Door Pulls

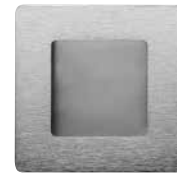

- › Solid metal construction
- › For use on sliding doors and panels
- › Fits 2-3/8" (60 mm) bore hole
- › Mounting screws included

### Double Hook

- › Solid Metal
- › 2-3/4" x 1-3/4" (70 mm x 44 mm)
- › Projection: 1" (25 mm)
- › Includes mounting screws



SATIN NICKEL 15	49-B5005SN	<b>\$10.50</b>
MATTE BLACK 19	49-B5005BLK	<b>\$10.50</b>
POLISHED CHROME 26	49-B5005	<b>\$10.50</b>
SATIN CHROME 26D	49-B5005SC	<b>\$10.50</b>
CASE QTY. 25 PKG. POLY BAGGED WITH UPC		

**Drive-In Adjustable Bullet Catch**

- › Zinc diecast body with steel ball
- › Adjustable for door gap
- › Fits into 1" (25 mm) bore
- › Strike included
- › Includes mounting screws



NICKEL FINISH 26	20-1432N	<b>\$9.92</b>
CASE QTY. 25 PKG. POLY BAGGED WITH UPC		

**Adjustable Bullet Catch**

- › Zinc diecast body with steel ball
- › Stamped steel strike plate included
- › Adjustable for door gap
- › Fits 13/16" (21 mm) bore hole
- › Includes mounting screws



POLISHED BRASS 3	20-1412B	<b>\$8.53</b>
OIL RUBBED BRONZE 10B	20-1412ORB	<b>\$9.39</b>
SATIN NICKEL 15	20-1412SN	<b>\$8.53</b>
ANTIQUE NICKEL 17A	20-1412AN	<b>\$8.53</b>
MATTE BLACK 19	20-1412BLK	<b>\$8.53</b>
POLISHED CHROME 26	20-1412CH	<b>\$8.53</b>
SATIN CHROME 26D	20-1412SC	<b>\$8.53</b>
CASE QTY. 25 PKG. POLY BAGGED WITH UPC		

**Double Roller Catch with C-Clip**

- › Steel construction
- › Plastic roller
- › Includes mounting screws



	20-1410Z	<b>\$2.23</b>
CASE QTY. 25 PKG. POLY BAGGED WITH UPC		

**Double Roller Catch**

- › Steel construction
- › Plastic roller
- › Includes mounting screws



	20-1420CH	<b>\$1.81</b>
CASE QTY. 25 PKG. POLY BAGGED WITH UPC		

**Flush Magnetic Catch**

- › Zinc plated steel strike
- › Plastic housing with magnet
- › Includes mounting screws



	20-1455AC	<b>\$2.96</b>
CASE QTY. 25 PKG. POLY BAGGED WITH UPC		

**Heavy Load Magnetic Catch**

- › Zinc plated steel strike
- › Plastic housing with magnet
- › Includes mounting screws
- › Holding capacity 16 lbs (7.3 kg)



	20-1465WH	<b>\$4.95</b>
CASE QTY. 25 PKG. POLY BAGGED WITH UPC		

**Notes**

- › Zinc diecast construction
- › Includes mounting screws

**A. Handrail Bracket**

- › Projection from wall is 3" (76 mm)



**B. Handrail Bracket 50 mm Clearance**

- › Projection from wall is 3-15/16" (100 mm)



**C. Heavy Duty Handrail Bracket 50 mm Clearance**

- › Projection from wall is 3-15/16" (100 mm)



	A.		B.		C.
POLISHED BRASS 3	25-P6350B	<b>\$6.00</b>	25-P6360PB	<b>\$8.46</b>	—
OIL RUBBED BRONZE 10B	25-P6350ORB	<b>\$6.52</b>	25-P6360ORB	<b>\$9.20</b>	25-P6370ORB <b>\$23.74</b>
SATIN NICKEL 15	25-P6350SN	<b>\$6.00</b>	25-P6360SN	<b>\$8.46</b>	25-P6370SN <b>\$21.78</b>
NICKEL 26	—	—	25-P6360N	<b>\$8.46</b>	—
ANTIQUE NICKEL 17A	25-P6350AN	<b>\$6.00</b>	25-P6360AN	<b>\$8.46</b>	—
MATTE BLACK 19	—	—	25-P6360BLK	<b>\$8.46</b>	25-P6370BLK <b>\$21.78</b>
SATIN CHROME 26D	25-P6350SC	<b>\$6.00</b>	25-P6360SC	<b>\$8.46</b>	25-P6370SC <b>\$21.78</b>
CASE QTY.	25		15		5
PKG. POLY BAGGED WITH UPC					

**INTERIOR HARDWARE DOOR SECURITY**



**Surface Bolt**

- › 4" (102 mm)
- › Solid brass construction
- › Includes 2 keepers and mounting screws

SATIN NICKEL 15	25-4035100SN	<b>\$10.64</b>
MATTE BLACK 19	25-4035100BLK	<b>\$10.64</b>
POLISHED CHROME 26	25-4035100PC	<b>\$10.64</b>

CASE QTY. 20 PKG. POLY BAGGED WITH UPC



**Flush Bolt - Radius End**

- › 6" (152 mm)
- › Solid brass and steel construction
- › Includes keeper and mounting screws

OIL RUBBED BRONZE 10B	25-53160RB	<b>\$24.55</b>
SATIN NICKEL 15	25-5316SN	<b>\$22.30</b>
MATTE BLACK 19	25-5316BLK	<b>\$22.30</b>
SATIN CHROME 26D	25-5316SC	<b>\$22.30</b>

CASE QTY. 20 PKG. POLY BAGGED WITH UPC

INTERIOR HARDWARE

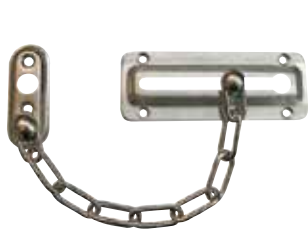

**Chain Door Guard**

- › Allows partial door opening while deterring forced access
- › Solid metal construction
- › Welded steel chain
- › Easy to install
- › Includes mounting screws in matching finish

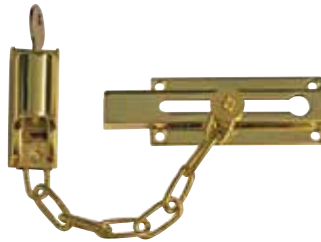

**Keyed Locking Chain Door Guard**

- › Locking key adds an extra measure of security
- › Solid metal construction
- › Includes 2 keys and mounting screws



**Door Guard**

- › Swings to lock or unlock and allows partial door opening while deterring forced access
- › Solid metal construction
- › Easy to install
- › Includes mounting screws in matching finish

	Chain Door Guard		Keyed Locking Chain Door Guard		Door Guard	
POLISHED BRASS 3	25-D4804PB	<b>\$6.61</b>	37-4815	<b>\$26.82</b>	25-D3080B	<b>\$14.30</b>
OIL RUBBED BRONZE 10B	25-D4804ORB	<b>\$7.28</b>	—	—	25-D3080ORB	<b>\$15.74</b>
SATIN NICKEL 15	25-D4804SN	<b>\$6.61</b>	—	—	25-D3080SN	<b>\$14.30</b>
SATIN CHROME 26D	25-D4804SC	<b>\$6.61</b>	—	—	25-D3080SC	<b>\$14.30</b>
CASE QTY.	5		10		10	

PKG. CARDED

**Door Frame Protector**

- › Protects door frame from open arm of door guard (25-D3080)
- › Aluminum
- › 1-1/16" (27 mm) wide



DULL CHROME	25-3082DC	<b>\$4.09</b>
-------------	-----------	---------------

CASE QTY. 50 PKG. BULK



**Cam Lock**

- > Key operated cabinet locks includes two steel cam stops (90° and 180° for various applications)
- > Zinc diecast construction
- > Complete with 2 keys



Maximum thickness	3/8" (10 mm)		5/8" (16 mm)	
POLISHED CHROME 26	37-3250	\$11.97	37-3260	\$13.49
CASE QTY. 10 PKG. CARDED				

**Chain Check - Heavy Duty**

- > Steel construction
- > Grey vinyl cover
- > Solid twisted chain
- > Heavy duty compression springs
- > Complete with fully threaded wood screws



30-1/2" (775 mm)				25-4860U30	\$49.79
CASE QTY. 6 PKG. POLY BAGGED WITH UPC					

**Pull & Push Plates**

- > Adds a decorative element to commercial and residential doors while protecting the surface from dirt, hand prints, and smudges
- > Pre-drilled holes for easy installation
- > 0.039-inch (1 mm) gauge aluminum
- > Includes self-tapping screws, suitable for metal or wood doors, in matching finish



Door Pull with Plate



Push Plate

	SATIN ALUMINUM		POLISHED BRASS 3		CASE QTY.
Door Pull with Plate - 9" (229 mm) pull, 4" x 16" (102 mm x 406 mm) plate	25-D400916	\$70.09	—		5
Push Plate - 4" x 16" (102 mm x 406 mm)	25-D416	\$32.79	25-D7316PB	\$55.03	10



# Commercial Locks & Hardware

Designed for today's demanding architectural requirements, Taymor's comprehensive line of commercial hardware delivers consistent, dependable performance across an array of applications. From cylindrical locks and deadbolts to door closers and exit hardware; our commercial program has everything necessary to keep your entryways fully functional and up to code.



DUKE LOCKSET | SATIN CHROME

## MAKING THE GRADE

Real world quality — Taymor continuously works to meet and exceed standards set by the Builders Hardware Manufacturers Association (BHMA) and the American National Standards Institute (ANSI) for builder's hardware. The standards are defined by grades in which there are progressive levels of performance benchmarks. The purpose of standardized ANSI/BHMA product grades is to help identify the quality and durability of door hardware through a series of operational and security tests.



ANSI GRADE 1



ANSI GRADE 2



ANSI GRADE 3

**Grade 1** is the strongest grade available for maximum duty commercial applications.

**Grade 2** is designed and built to offer excellent security and durability for heavy-duty commercial applications.

**Grade 3** offers reliable security for both residential and light-commercial projects.

COMMERCIAL LOCKSETS & DEADBOLTS

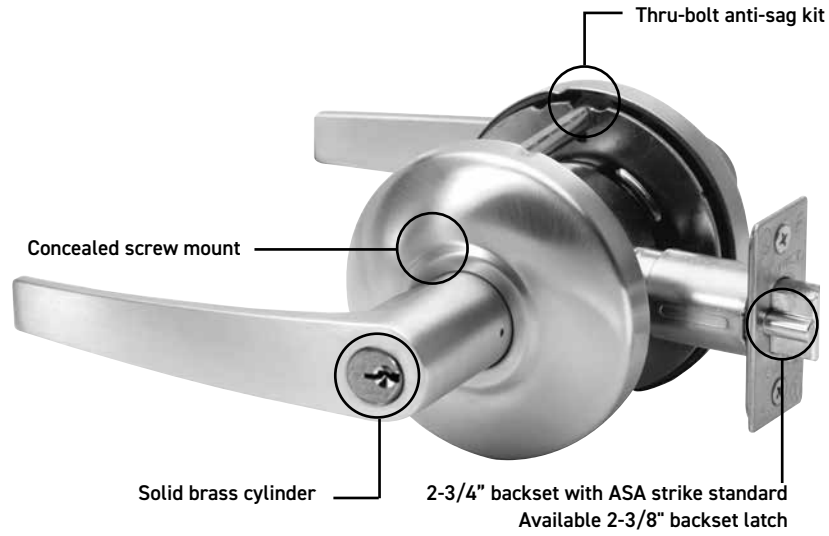

COMMERCIAL LOCKS & HARDWARE

**Knight**



**Notes**

ANSI/BHMA 156.2 grade 1  
Maximum duty cylindrical construction

Reversible lock  
Concealed screw mount

**GRADE 1**  
ANSI GRADE 1



**FULL KEYING SERVICES AVAILABLE**  
6-pin SC4 keyway, packaged keyed different

**Grade 1 Deadbolt**



Fixed backset 2-3/4" (70 mm) 10 year mechanical warranty  
1-1/8" x 2-1/4" (28 mm x 57 mm) square mortise latch

**FIRE RATED**  
Meets c-UL and UL 3-hour fire rating standard

<b>Knight</b>	<b>ENTRY</b> ANSI FUNCTION #F109	<b>PRIVACY</b> ANSI FUNCTION #F76	<b>PASSAGE</b> ANSI FUNCTION #F75	<b>STOREROOM</b> ANSI FUNCTION #F86	<b>CLASSROOM</b> ANSI FUNCTION #F84
<b>SATIN CHROME 26D</b>	32-6953 <b>\$348.57</b>	32-6940 <b>\$310.25</b>	32-6910 <b>\$296.29</b>	32-6980 <b>\$348.57</b>	32-6970 <b>\$418.31</b>

CASE QTY. 6

<b>Grade 1 Deadbolt</b>	<b>SINGLE CYLINDER</b>
<b>POLISHED CHROME 26</b>	32-F740 <b>\$176.37</b>
<b>SATIN CHROME 26D</b>	32-F780 <b>\$187.30</b>

CASE QTY. 12 PKG. BOX PACK

**Citadel**



**Duke**



New Finish Coming Soon!

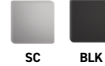

**Notes**

ANSI/BHMA 156.2 grade 2

Heavy duty cylindrical construction

Reversible lock

5 year mechanical warranty

Fixed backset 2-3/4" (70 mm)



ANSI GRADE 2



**FULL KEYING SERVICES AVAILABLE**

6-pin SC4 keyway, packaged keyed different



**FIRE RATED**

Meets c-UL 3-hour fire rating standard

	ENTRY Entrance/Office leverset (inside turn button) ANSI FUNCTION # F109	PRIVACY Restroom leverset (inside push button) ANSI FUNCTION # F76	PASSAGE Hall/Closet leverset ANSI FUNCTION # F75	STOREROOM ANSI FUNCTION # F86
<b>Citadel</b>				
SATIN CHROME 26D	32-5553C26D <b>\$250.33</b>	32-5540C26D <b>\$222.79</b>	32-5510C26D <b>\$212.77</b>	32-5580C26D <b>\$250.33</b>
CASE QTY.	6	6	6	6
	CLASSROOM ANSI FUNCTION # F84	COMMUNICATING PASSAGE / EXIT NON-KEY ANSI FUNCTION # F111	INSTITUTION ANSI FUNCTION # F87	DUMMY Single side leverset
SATIN CHROME 26D	32-5570C26D <b>\$275.37</b>	32-5525C26D <b>\$207.77</b>	32-5582C26D <b>\$300.38</b>	32-5593C26D <b>\$100.15</b>
CASE QTY.	6	6	6	12

	ENTRY Entrance/Office leverset (inside turn button) ANSI FUNCTION # F109	ENTRY 3/4" (19 mm) latch** ANSI FUNCTION # F109	PRIVACY Restroom leverset (inside push button) ANSI FUNCTION # F76	PRIVACY 3/4" (19 mm) latch** ANSI FUNCTION # F76	
<b>Duke</b>					
MATTE BLACK 19	32-7953BLK <b>\$256.77</b>	-	32-7940BLK <b>\$228.52</b>	-	
MATTE BLACK 19 (Clutch)	32-5953BLK* <b>\$282.44</b>	-	-	-	
SATIN CHROME 26D	32-7953 <b>\$244.54</b>	32-795334SC <b>\$459.05</b>	32-7940 <b>\$217.64</b>	32-794034SC <b>\$436.47</b>	
SATIN CHROME 26D (Clutch)	32-5953* <b>\$268.99</b>	-	32-5940* <b>\$242.08</b>	-	
CASE QTY.	10	6	10	6	
	PASSAGE Hall/closet leverset ANSI FUNCTION # F75	PASSAGE 3/4" (19 mm) latch** ANSI FUNCTION # F75	STOREROOM ANSI FUNCTION # F86	STOREROOM 3/4" (19 mm) latch** ANSI FUNCTION # F86	
MATTE BLACK 19	32-7910BLK <b>\$218.24</b>	-	32-7980BLK <b>\$256.77</b>	-	
MATTE BLACK 19 (Clutch)	-	-	32-5980BLK* <b>\$282.44</b>	-	
SATIN CHROME 26D	32-7910 <b>\$207.85</b>	32-791034SC <b>\$436.47</b>	32-7980 <b>\$244.54</b>	32-798034SC <b>\$464.61</b>	
SATIN CHROME 26D (Clutch)	-	-	32-5980* <b>\$268.99</b>	-	
CASE QTY.	10	6	10	6	
	CLASSROOM ANSI FUNCTION # F84	CLASSROOM 3/4" (19 mm) latch** ANSI FUNCTION # F84	COMMUNICATING PASSAGE / EXIT NON-KEY ANSI FUNCTION # F111	COMMUNICATING PASSAGE 3/4" (19 mm) latch** ANSI FUNCTION # F111	DUMMY Single side leverset
MATTE BLACK 19	32-7970BLK <b>\$282.44</b>	-	32-7925BLK <b>\$213.11</b>	-	32-7993BLK <b>\$102.72</b>
MATTE BLACK 19 (Clutch)	32-5970BLK* <b>\$308.10</b>	-	-	-	-
SATIN CHROME 26D	32-7970 <b>\$268.99</b>	32-797034SC <b>\$504.21</b>	32-7925 <b>\$202.96</b>	32-792534SC <b>\$481.64</b>	32-7993 <b>\$97.83</b>
SATIN CHROME 26D (Clutch)	32-5970* <b>\$293.43</b>	-	-	-	-
CASE QTY.	10	6	10	6	10

\*Clutch mechanism. \*\*For rated paired door application per NFPA80.

# COMMERCIAL LOCKSETS & DEADBOLTS

## Notes

- ANSI/BHMA 156.2 grade 2
- Heavy duty cylindrical construction
- Reversible lock
- Fixed backset 2-3/4 (70 mm)
- 5 year mechanical warranty

## Excalibur



## York



GRADE 2

ANSI GRADE 2



**FULL KEYING SERVICES AVAILABLE**  
6-pin SC4 keyway, packaged keyed different



**FIRE RATED**  
Meets c-UL 3-hour fire rating standard

	ENTRY Entrance/Office leverset (inside turn button) ANSI FUNCTION # F109	PRIVACY Restroom leverset (inside turn button) ANSI FUNCTION # F176	PASSAGE Hall/Closet leverset ANSI FUNCTION # F75	STOREROOM ANSI FUNCTION # F86	CLASSROOM ANSI FUNCTION # F84
<b>Excalibur</b>					
SATIN CHROME 26D	32-4953* <b>\$268.99</b>	32-4940 <b>\$242.08</b>	32-4910 <b>\$207.85</b>	32-4980* <b>\$268.99</b>	32-4970* <b>\$293.43</b>
CASE QTY.	10	10	10	10	10

\*Clutch mechanism.

	ENTRY Entrance/Office leverset (inside turn button) ANSI FUNCTION # F109	PRIVACY Restroom leverset (inside turn button) ANSI FUNCTION # F176	PASSAGE Hall/Closet leverset ANSI FUNCTION # F75	STOREROOM ANSI FUNCTION # F86
<b>York</b>				
SATIN STAINLESS STEEL 32D	32-8953 <b>\$119.66</b>	32-8940 <b>\$106.49</b>	32-8910 <b>\$101.70</b>	32-8980 <b>\$119.66</b>
CASE QTY.	20	20	20	20

	CLASSROOM ANSI FUNCTION # F84
SATIN STAINLESS STEEL 32D	32-8970 <b>\$131.65</b>
CASE QTY.	20

## Deadbolts



New Finish!

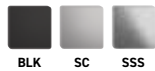

**\*A. COMMERCIAL SINGLE CYLINDER DEADBOLT**



**\*B. SINGLE SIDED COMMUNICATING DEADBOLT**



**C. OCCUPANCY INDICATOR DEADBOLT**  
SHOWING RED "LOCKED" AND GREEN "UNLOCKED" ICONS

## Notes

- ANSI/BHMA 156.2 grade 2
- Solid brass cylinder
- 2-in-1 adjustable backset latch 2-3/8" to 2-3/4" (61 mm to 70 mm) for A & C
- Fixed backset latch 2-3/4" (61 mm) for B
- 1" x 2-1/4" (25 mm x 57 mm) square mortise faceplate
- 5 year mechanical warranty

GRADE 2

ANSI GRADE 2



A. & B.\*



**FULL KEYING SERVICES AVAILABLE**  
6-pin SC4 keyway, packaged keyed different



**FIRE RATED A. & B.\***  
Meets c-UL and UL 3-hour fire rating standard



**MEETS ADA STANDARDS FOR ITEM A.\***

	*A. COMMERCIAL SINGLE CYLINDER DEADBOLT	*B. SINGLE SIDED COMMUNICATING DEADBOLT	C. OCCUPANCY INDICATOR DEADBOLT
<b>BOX PACK</b>			
MATTE BLACK 19	32-F480BLK <b>\$150.99</b>	-	-
SATIN CHROME 26D	32-F470 <b>\$133.15</b>	32-F218 <b>\$110.56</b>	32-F238 <b>\$117.06</b>
SATIN STAINLESS STEEL 32D	32-F450 <b>\$119.84</b>	-	32-F238SSS <b>\$105.35</b>
CASE QTY.	20	20	20

**Oxford**



**Windsor**



**Single Cylinder Deadbolt**



**Notes**

ANSI/BHMA 156.2 grade 2

Light duty tubular construction

Solid brass cylinder

5 year mechanical warranty

Reversible lock

2-in-1 adjustable backset latch



**ANSI GRADE 2**



**FULL KEYING SERVICES AVAILABLE**

6-pin SC4 keyway, packaged keyed different



**FIRE RATED**

Meets c-UL and UL 3-hour fire rating standard

	ENTRY Entrance/Office knobset (inside turn button)		PRIVACY Restroom knobset (inside turn button)		PASSAGE Hall/Closet knobset		STOREROOM	
<b>Oxford</b>								
VISUAL PACK								
SATIN STAINLESS STEEL 32D	32-V1653	<b>\$114.33</b>	32-V1640	<b>\$98.01</b>	32-V1610	<b>\$87.12</b>	32-V1680	<b>\$114.33</b>
CASE QTY.	3		4		4		4	

	ENTRY Entrance/Office knobset (inside turn button)		PRIVACY Restroom leverset (inside turn button)		PASSAGE Hall/Closet leverset		STOREROOM	
<b>Windsor</b>								
VISUAL PACK								
SATIN STAINLESS STEEL 32D	32-V1853	<b>\$205.45</b>	32-V1840	<b>\$184.90</b>	32-V1810	<b>\$164.38</b>	32-V1880	<b>\$215.74</b>
CASE QTY.	4		4		4		4	

<b>Deadbolt</b>	COMMERCIAL SINGLE CYLINDER DEADBOLT (w/T-Strike)							
VISUAL PACK								
SATIN STAINLESS STEEL 32D	32-FV450	<b>\$122.47</b>						
CASE QTY.	3							

Duke Mortise

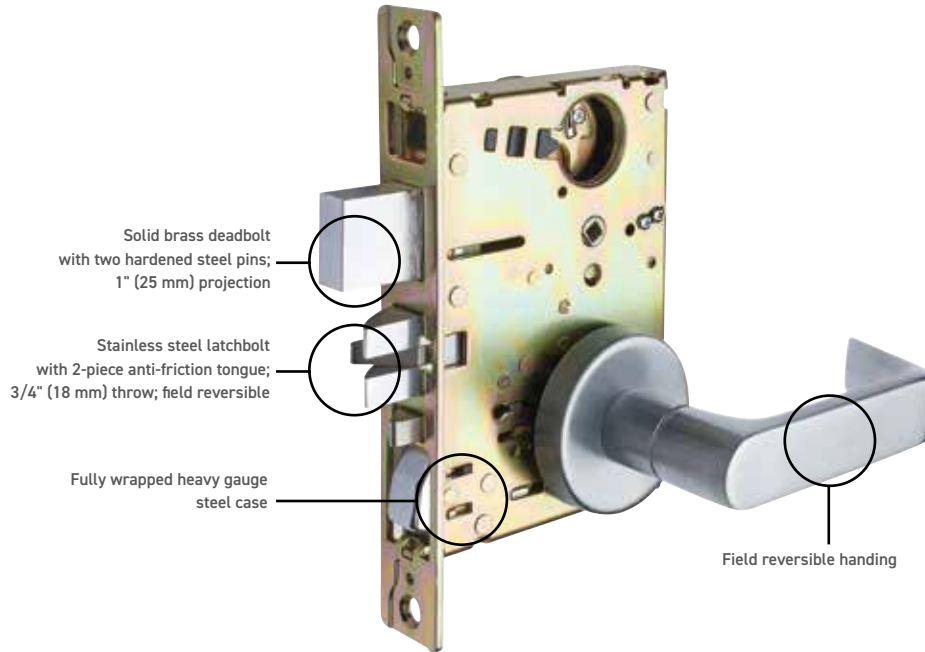

ANSI GRADE 1



FULL KEYING SERVICES AVAILABLE

6-pin SC4 keyway, packaged keyed different



FIRE RATED

Meets c-UL and UL 3-hour fire rating standard



DUKE MORTISE

SATIN CHROME 26D	ANSI FUNCTION	ROUND SECTIONAL TRIM	
Passage	F01	39-S1077C26D	\$774.54
Privacy	F19	39-S4077C26D	\$790.51
Apartment/Corridor	F20	39-S5077C26D	\$810.44
Dormitory	F13	39-S5677C26D	\$770.78
Exit	F12	39-S5777C26D	\$718.63
Office/Entry	F04	39-S6077C26D	\$798.48
Classroom	F05	39-S7077C26D	\$798.48
Storeroom/Closet	F07	39-S8077C26D	\$798.48

MORTISE (without trim) **New!**

SATIN CHROME 26D	ANSI FUNCTION		
Storeroom/Closet	F07	39-S80C26D	\$522.52

Order cylinders separately for keyed functions. Minimum quantities and lead times apply. Taymor Mortise cylinders may be compatible with other brands. Please contact your Taymor sales representative for details.



MORTISE CYLINDERS (sold separately)

SC4 6 pin 'C' keyway, 1-1/8"D (28 mm) - for sectional trim	39-MSCYL118C26D	\$72.26
CASE QTY. 100		

MORTISE LOCK ACCESSORIES

CLOVERLEAF CAM FOR MORTISE CYLINDERS	39-CLCAM	\$ 4.19
CASE QTY. 10		





4000 Series

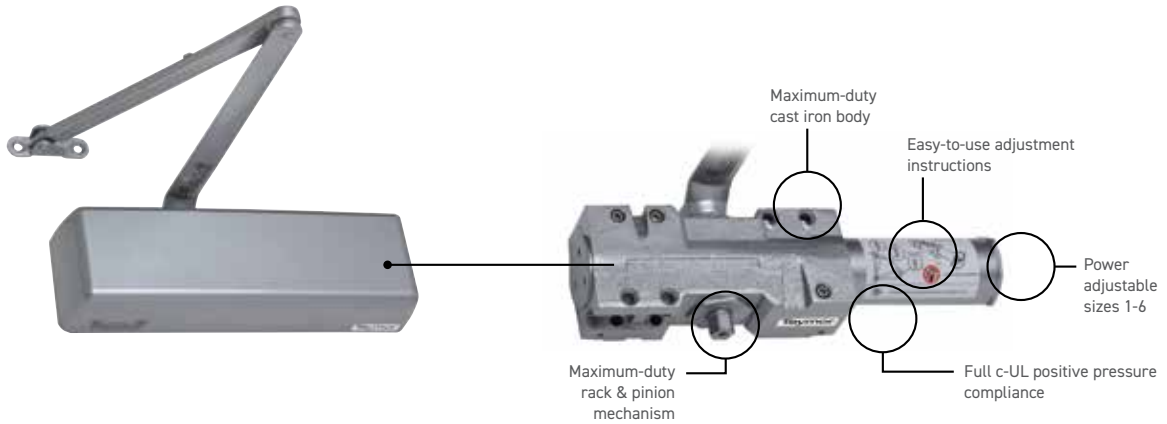

Notes

ANSI/BHMA 156.4 grade 1

UL and c-UL listed; c-UL10 for positive pressure

Closing power adjustable from sizes 1 to 6

Barrier-free operation for the strictest requirements in accessibility

Will fit all sizes and weights of swinging doors

Ideally suited for doors in the highest traffic areas

Standard backcheck, sweep and latching speed

Universal mounting; regular and parallel bracket included

Non-handed installation

Cast iron body

10 year mechanical warranty



MEETS ADA STANDARDS

SIZE	MAXIMUM RECOMMENDED DOOR SIZE & WEIGHT	ALUMINUM 28	
1-6	48" x 96" (121cm x 243cm), 266 lbs (121 kg)	13-4000AL	\$457.14
CASE QTY. 4 PKG. BOX PACK			

4000 Series Parts & Accessories

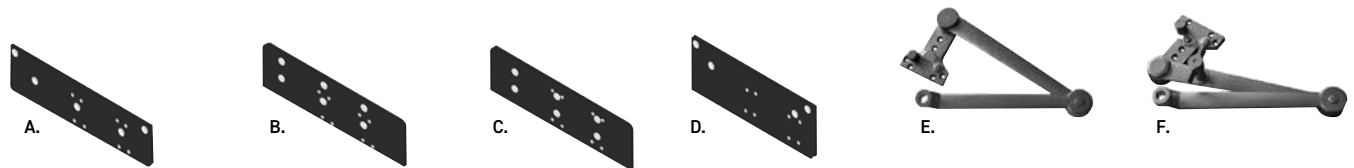

ALUMINUM 28			
A.	Drop Plate - regular arm mount	13-A4000DPRAL	\$45.86
B.	Drop Plate - low clearance mount	13-A4000DPLCAL	\$45.86
C.	Drop Plate - top jamb mount	13-A4000DPTJAL	\$44.42
D.	Drop Plate - parallel arm mount	13-A4000PAMAL	\$59.24
E.	Cush stop arm	13-A4000CSAL	\$117.01
F.	Cush stop hold open arm* - maximum door weight 60 kg (132 lbs)	13-A4000CSHOAL	\$119.85

CASE QTY. 10

\* NOT FOR USE ON FIRE-RATED DOORS

# COMMERCIAL DOOR CLOSERS

## 1900 Series



### Notes

UL and c-UL listed; c-UL10c for positive pressure

Closing power adjustable from sizes 1 to 6

Barrier-free operation for the strictest requirements in accessibility

Delayed action functionality included with 13-1900BFDAAL and 13-1900BFDABLK

Will fit all sizes and weights of swinging doors

Comes with thru-bolts

Standard backcheck, sweep and latching speed

Universal mounting; regular and parallel bracket included

Non-handed installation

Aluminum die-cast body

10 year mechanical warranty



ANSI GRADE 1



MEETS ADA STANDARDS

SIZE	MAXIMUM RECOMMENDED DOOR SIZE & WEIGHT	DESCRIPTION	MATTE BLACK 19	ALUMINUM 28
1-6	48" x 96" (121cm x 243cm), 266 lbs (121 kg)	Adjustable power 1 through 6 with standard backcheck and barrier free	13-1900BLK	13-1900AL
			<b>\$262.61</b>	<b>\$262.61</b>
1-6	48" x 96" (121cm x 243cm), 266 lbs (121 kg)	Adjustable power 1 through 6 with standard backcheck, barrier free and delayed action	13-1900BFDABLK	13-1900BFDAAL
			<b>\$267.47</b>	<b>\$267.47</b>

CASE QTY. 6 PKG. BOX PACK

## 1900 Series Parts & Accessories

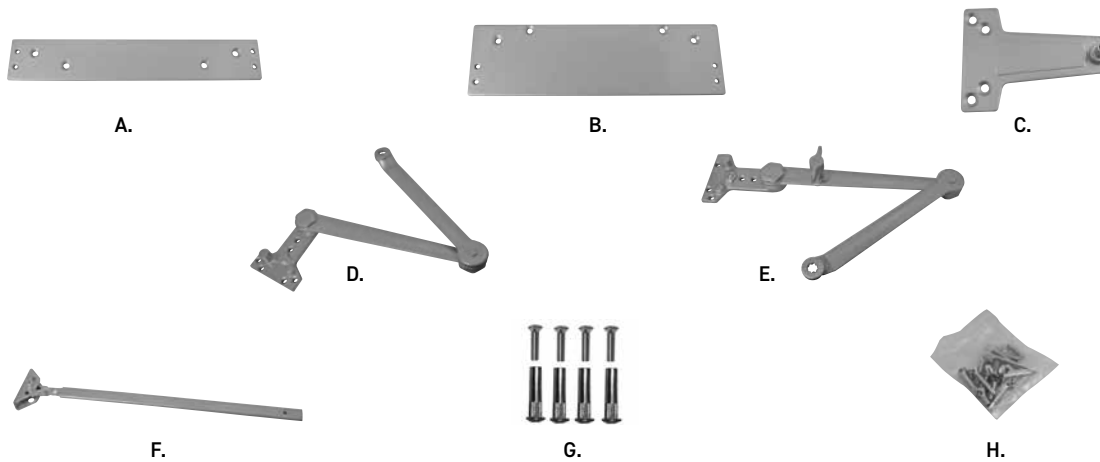

		MATTE BLACK 19	ALUMINUM 28	CASE QTY.
A.	Regular or top jamb narrow drop plate - 2" tall (51mm)	13-A1900DP51BLK	13-A1900DP51AL	10
		<b>\$ 36.42</b>	<b>\$ 36.42</b>	
B.	Parallel arm drop plate - 3-9/16" tall (90 mm)	13-A1900DP90BLK	13-A1900DP90AL	10
		<b>\$ 50.97</b>	<b>\$ 50.97</b>	
C.	Parallel arm bracket	13-A1900PABBLK	13-A1900PABAL	100
		<b>\$ 7.03</b>	<b>\$ 7.03</b>	
D.	Cush stop arm	13-A1900CSABLK	13-A1900CSAAL	10
		<b>\$112.84</b>	<b>\$112.84</b>	
E.	Cush stop hold open arm* - maximum door weight 60kg (132lbs)	13-A1900CSHOABLK	13-A1900CSHOAAL	10
		<b>\$119.85</b>	<b>\$119.85</b>	
F.	Extended long rod and shoe	13-A1900ELRSBLK	13-A1900ELRSAL	50
		<b>\$ 11.27</b>	<b>\$ 11.27</b>	
G.	Thru bolts	13-A1900SNBBLK	13-A1900SNBAL	100
		<b>\$ 10.59</b>	<b>\$ 10.59</b>	
H.	Screw pack	13-A1900SPBLK	13-A1900SPAL	100
		<b>\$ 7.03</b>	<b>\$ 7.03</b>	

\* NOT FOR USE ON FIRE-RATED DOORS

**550 Series**



**Notes**

ANSI/BHMA 156.4 grade 2

Spring size 2, 3 and 4

High strength aluminum alloy body

Non-handed installation

Two independent adjustable valves control sweeping and latching speed

Universal mounting (regular and parallel brackets included)

Supplied with machine and wood screws

5 year mechanical warranty



**ANSI GRADE 2**



SIZE	MAXIMUM RECOMMENDED DOOR SIZE & WEIGHT	ALUMINUM 28	
2	36" x 84" (90 cm x 210 cm), 55-100 lbs (25-45 kg)	13-552APAL	<b>\$151.73</b>
3	38" x 84" (95 cm x 210 cm), 88-144 lbs (40-64 kg)	13-553APAL	<b>\$161.85</b>
4	42" x 96" (105 cm x 240 cm), 132-187 lbs (60-84 kg)	13-554APAL	<b>\$177.03</b>

CASE QTY. 10

**600 Series**



**Notes**

ANSI/BHMA 156.4 grade 3

Spring size 2, 3 and 4

High strength aluminum alloy body

Non-handed installation

Two independent adjustable valves control sweeping and latching speed

Universal mounting (regular and parallel brackets included)

Supplied with machine and wood screws

5 year mechanical warranty



**ANSI GRADE 3**



SIZE	MAXIMUM RECOMMENDED DOOR SIZE & WEIGHT	MATTE BLACK 19	POLISHED CHROME 26	ALUMINUM 28	CASE QTY.
2	36" x 83" (85 cm x 210 cm), 55-99 lbs (25-45 kg)	14-HC602BLK <b>\$91.05</b>	—	14-HC602AL <b>\$91.05</b>	10
3	37" x 83" (95 cm x 210 cm), 99-143 lbs (45-65 kg)	14-HC603BLK <b>\$106.22</b>	14-1623C26* <b>\$160.32</b>	14-HC603AL <b>\$106.22</b>	10
4	41" x 95" (105 cm x 240 cm), 143-187 lbs (65-85 kg)	—	—	14-HC604AL <b>\$136.56</b>	10
	Decorative cover	14-C1600BLK <b>\$17.58</b>	—	14-C1600AL <b>\$17.58</b>	50

\*DECORATIVE COVER INCLUDED IN POLISHED CHROME FINISH

**690 Series**



**Notes**

ANSI/BHMA 156.4 grade 3

Spring size 3, 4 and 5

High strength aluminum alloy body

Non-handed installation

Three independent adjustable valves control backcheck, sweeping and latching speed

Universal mounting (regular and parallel brackets included)

Supplied with machine and wood screws

5 year mechanical warranty



**ANSI GRADE 3**



SIZE	MAXIMUM RECOMMENDED DOOR SIZE & WEIGHT	ALUMINUM 28	
3	38" x 84" (95 cm x 210 cm), 100-187 lbs (45-85 kg)	14-693AL	<b>\$140.29</b>
4	42" x 96" (105 cm x 240 cm), 144-220 lbs (65-100 kg)	14-694AL	<b>\$170.34</b>

CASE QTY. 6

**COMMERCIAL EXIT HARDWARE**



8500 SERIES PUSH PAD EXIT DEVICE

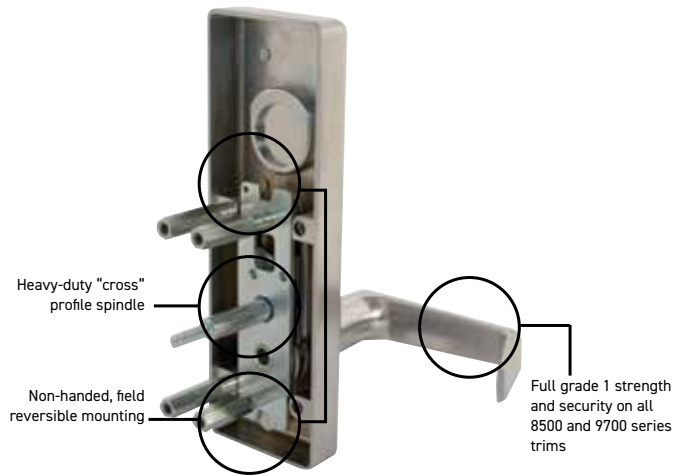

**8500 Series Push Pad Exit Device**



**FIRE RATING AVAILABLE**  
Meets c-UL 1.5-hour fire rating standard

**Notes**

8500 Series Safety Rated,  
F8500 Series Fire Rated

Designed for use on wood or  
hollow metal doors

Fits standard doors 1-3/8" - 1-3/4"

2-1/8" (54 mm) bore hole, 2-3/4"  
(70 mm) backset

Non-handed installation

Dogging capability for safety rated

Vertical rods may be cut for  
smaller doors

One length available: 36" (91 cm)

Crossbar can be cut down by  
a maximum of 8" (20 cm)

5 year mechanical warranty

SAFETY RATED	ALUMINUM 28	CASE QTY.
8500 Series rim exit device for 28" - 36" door (71 cm - 91 cm)	17-8536AL <b>\$400.81</b>	6
8500 Series surface vertical rod exit device for 28" - 36" door (71 cm - 91 cm) apply to max 84" (213.4 cm) door height	17-8536VAL <b>\$701.42</b>	4
FIRE RATED	ALUMINUM 28	CASE QTY.
8500 Series rim exit device for 28" - 36" door (71 cm - 91 cm)	17-F8536AL <b>\$501.02</b>	6
8500 Series surface vertical rod exit device for 28" - 36" door (71 cm - 91 cm) apply to max 84" (213.4 cm) door height	17-F8536VAL <b>\$801.62</b>	4

**9700 Series Push Pad Exit Device**

- › 9700 Series Safety Rated, F9700 Series Fire Rated
- › Designed for use on wood or hollow metal doors
- › Fits standard doors - 2-1/8" (54 mm) bore hole, 2-3/4" (70 mm) backset
- › Non-handed
- › Dogging capability for safety rated
- › Vertical rods may be cut for smaller doors
- › Two lengths available: 36" (91 cm) and 48" (122 cm)
- › Crossbar can be cut down by a maximum of 8" (20 cm)
- › 10 year mechanical warranty

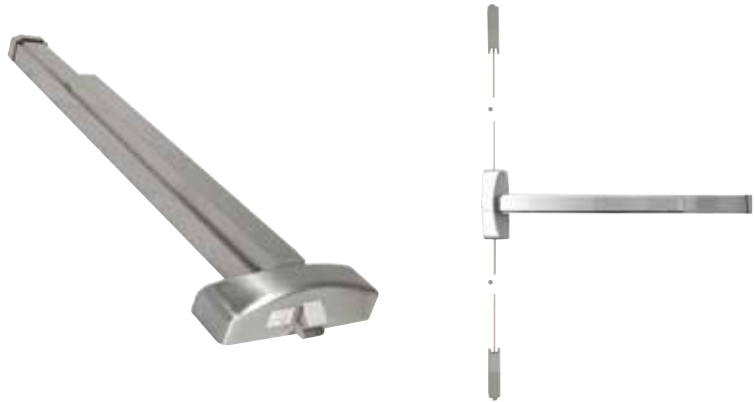

**ANSI GRADE 1**



**FIRE RATING AVAILABLE**

Meets c-UL 3-hour fire rating standard

**New Finish  
Coming Soon!**

SAFETY RATED	MATTE BLACK 19	STAINLESS STEEL 32D
9700 Series rim exit device for 28" - 36" door (71 cm - 91 cm)	17-9736BLK <b>\$ 851.72</b>	17-9736SSS <b>\$ 851.72</b>
9700 Series surface mount vertical rod exit device for 28" - 36" door (71 cm - 91 cm) x 84" (213 cm)	17-9736VBLK <b>\$1252.51</b>	17-9736VSSS <b>\$1252.51</b>
9700 Series rim exit device for 37" - 48" door (94 cm - 122 cm)	17-9748BLK <b>\$ 908.47</b>	17-9748SSS <b>\$ 908.47</b>
9700 Series surface mount vertical rod exit device for 37" - 48" door (94 cm - 122 cm) x 96" (244 cm)	17-9748VBLK <b>\$1312.17</b>	17-9748VSSS <b>\$1312.17</b>

CASE QTY. 2

**New Finish  
Coming Soon!**

FIRE RATED	MATTE BLACK 19	STAINLESS STEEL 32D
9700 Series rim exit device for 28" - 36" door (71 cm - 91 cm)	17-F9736BLK <b>\$ 976.96</b>	17-F9736SSS <b>\$ 976.96</b>
9700 Series surface mount vertical rod exit device for 28" - 36" door (71 cm - 91 cm) x 84" (213 cm)	17-F9736VBLK <b>\$1312.17</b>	17-F9736VSSS <b>\$1312.17</b>
9700 Series rim exit device for 37" - 48" door (94 cm - 122 cm)	17-F9748BLK <b>\$1102.22</b>	17-F9748SSS <b>\$1102.22</b>
9700 Series surface mount vertical rod exit device for 37" - 48" door (94 cm - 122 cm) x 96" (244 cm)	17-F9748VBLK <b>\$1431.46</b>	17-F9748VSSS <b>\$1431.46</b>

CASE QTY. 2



**9700 SERIES PUSH PAD EXIT DEVICE ACCESSORIES**

	SATIN STAINLESS STEEL 32D
Vertical surface rod replacement kit for 9700 Series - 8' rod	17-97VRTROD8SSS <b>\$155.31</b>

CASE QTY. 20

**8500/9700 Series Knob and Lever Trim**

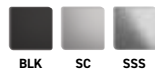
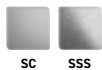

**MEETS  
ADA STANDARDS**

- › Maximum-duty actuating mechanism
- › Compatible with 8500 & 9700 series push pad exit device
- › 5 year mechanical warranty



**FULL KEYING SERVICES AVAILABLE**

6-pin SC4 keyway, packaged keyed different

**New Finish  
Coming Soon!**

	KNOB SATIN CHROME 26D	LEVER MATTE BLACK 19	LEVER STAINLESS STEEL 32D
Entry (classroom) function	17-ENBKAL <b>\$137.78</b>	17-LEVBLK <b>\$244.79</b>	17-LEVAL <b>\$244.79</b>
Storeroom function	17-SRBKAL <b>\$197.46</b>	17-SRLEVBLK <b>\$282.02</b>	17-SRLEVAL <b>\$282.02</b>
Passage function	—	17-PALEVBLK <b>\$222.90</b>	17-PALEVSC <b>\$222.90</b>

CASE QTY. 20

**8500/9700 Series Outside Thumbpiece Trims**



A. B. C. D.

- › Maximum-duty actuating mechanism
- › Compatible with push pad exit device series 9700 and 8500
- › Non-handed outside thumbpiece trims
- › Rim cylinder for storeroom function
- › Mortise cylinder for entry function
- › 5 year mechanical warranty



**FULL KEYING SERVICES AVAILABLE**

6-pin SC4 keyway, packaged keyed different

**New Finish  
Coming Soon!**

	MATTE BLACK 19		ALUMINUM 28	
A. Entry (classroom) function	17-ENTPBLK	<b>\$260.52</b>	17-ENTPAL	<b>\$260.52</b>
B. Storeroom function	17-STTPBLK	<b>\$260.52</b>	17-STTPAL	<b>\$260.52</b>
C. Passage function	17-PSTPBLK	<b>\$240.48</b>	17-PSTPAL	<b>\$240.48</b>
D. Dummy function	17-DUPBLK	<b>\$210.43</b>	17-DUPAL	<b>\$210.43</b>

CASE QTY. 10

**8500/9700 Series Escutcheon Lever Trim**



SC



**FULL KEYING SERVICES AVAILABLE**

6-pin SC4 keyway, packaged keyed different



**MEETS ADA  
STANDARDS**



- › Maximum-duty actuating mechanism
- › Compatible with 8500 & 9700 series push pad exit device
- › Mortise cylinder for entry (classroom) and storeroom function
- › 5 year mechanical warranty

	SATIN CHROME 26D	
Entry (classroom) function	17-ESCU70SC	<b>\$375.76</b>
Storeroom function	17-ESCU80SC	<b>\$375.76</b>
Passage function	17-ESCU55SC	<b>\$290.38</b>

CASE QTY. 8

**8500/9700 Series Escutcheon Lever Trim Accessories**

**New Finish  
Coming Soon!**

	MATTE BLACK 19		ALUMINUM 28	
 Rim cylinder (for use with 9700/8500 series Outside Thumbpiece Trim) SC4 'C' keyway – 6 pin WR5 keyway – 6 pin CASE QTY. 100	17-SS800ABLK	<b>\$144.00</b>	17-SS800AAL	<b>\$77.15</b>
	-	-	17-SW800AAL	<b>\$77.15</b>
 Mortise cylinder (1-1/8" - 28 mm) (for use with 9700/8500 series Escutcheon Trim) SC4 'C' keyway – 6 pin WR5 keyway – 6 pin CASE QTY. 10	-	-	17-DBS61	<b>\$60.98</b>
	-	-	17-DB61	<b>\$75.16</b>

**900 Series Push Bar Exit Device**



**MEETS  
ADA STANDARDS**

- › Designed for use on wood or hollow metal doors
- › Heavy duty steel construction
- › Fits standard door thickness: Maximum of 2" (51 mm)
- › Dogging capability
- › Rim cylinder for entry function must be ordered separately
- › Complete with 38" (97 cm) standard cross bar
- › 5 year mechanical warranty







**EXTERIOR ACCESS BY KEY & THUMB LATCH ENTRY (CLASSROOM) FUNCTION**  
KEY UNLOCKS THUMB LATCH (cylinder not included)

	ALUMINUM 28	
Right hand reverse opening	17-950ALRR	<b>\$465.50</b>
Left hand reverse opening	17-950ALLR	<b>\$465.50</b>
<b>CASE QTY. 6</b>		

**900 Series Escutcheon Lever Trim Accessories**

	Rim cylinder (for use with 900 series) SC4 'C' keyway – 6 pin	17-S800AAL	<b>\$53.46</b>
<b>CASE QTY. 100</b>			

**Exit Hardware Accessories**

		ALUMINUM 28	CASE QTY.
	Exit only plate, where no building access required on exterior doors 3-1/2" x 5" (89 mm x 127 mm)	17-EOPAL	<b>\$27.36</b> 80
	Pull profile with cylinder hole and rim cylinder socket Latch bolt is retracted by key from outside. Cylinder not included, trim mounting plate included (17-PPMTMP) 3-1/2" x 6-1/4" (89 mm x 159 mm)	17-PP05AL	<b>\$58.11</b> 20
	Lip pull with cylinder hole for rim cylinder Latch bolt is retracted by key from outside. Cylinder not included, trim mounting plate included (17-PPMTMP) 1-3/4" x 3" (45 mm x 75 mm)	17-LP01AL	<b>\$26.25</b> 6
	Trim mounting plate	17-PPMTMP	<b>\$ 6.26</b> 20
	Overlap strike for double door applications	17-PS09AL	<b>\$45.60</b> 100
	Standard cam for mortise cylinder (for use with 8500 series)	17-STDCAM	<b>\$ 4.56</b> 500
	Adams rite cam for mortise cylinder	17-ARCAM	<b>\$ 4.52</b> 10



## Pro/Key Program

Ensure safe and accurate key-control with our Pro/Key services. From a simple keyed alike system operated by one key, to a more complex multi-level grand master keying system, we work directly with design and development teams to identify the best keying options for the project. If you can't find a solution that works for your project, please contact our Sales team.



### Keyway Options

Available in a Weiser WR5 5-pin keyway:

- Professional Series
- Builder Series - Orleans Lever and Gala Ball Knob
- Epic Series
- Premier Visual Pack Deadbolts

Available in a Schlage SC4 6-pin keyway:

- Premier Series
- Interconnected Locks
- Mortise Locks
- Professional Series Deadbolts
- Builder Series - Deadbolts and Perspective and Silver Moon Levers
- Commercial Locks (WR5 keyway available on request)

### Keying Options

ALSO SEE FACING PAGE FOR COMMON KEYING OPTIONS >

Combination of Master & Construction Keying

Combination of Master & Double Knockout Construction Keying

Combination of Grand Master & Construction Keying

Combination of Grand Master & Double Knockout Construction Keying

Customer Specific Keying Available

### Additional Services

Custom logo keys

Custom escutcheon etching

Custom key stamping and cylinder marking

Minimum quantities and lead times apply. Please contact Taymor for details.



# Keying Options

**KEYED ALIKE (KA)** systems are a perfect solution for single-family homes where homeowners may want one key to open multiple locks; for example, the front entrance and the back door.

**KEYED DIFFERENT (KD)** systems are common in multi-family buildings where each unit opens with a unique key.

**MASTER KEYING (MK)** systems are common in multi-family, commercial and institutional buildings where multiple levels of building access are required. Individual units each have a unique key and the master key permits access to all units for maintenance, and management staff as well as first responders.

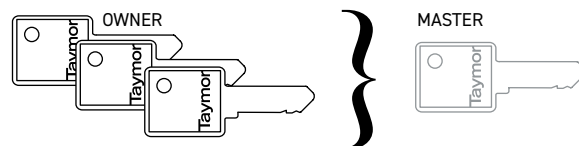

**GRAND MASTER KEYING (GMK)** allows the owner or strata responsible for multiple buildings to have one grand master key that operates all locks. Individual units have a unique key while each building has a master key that permits access to all areas—or to targeted areas—for tenants, maintenance, and management staff as well as first responders.

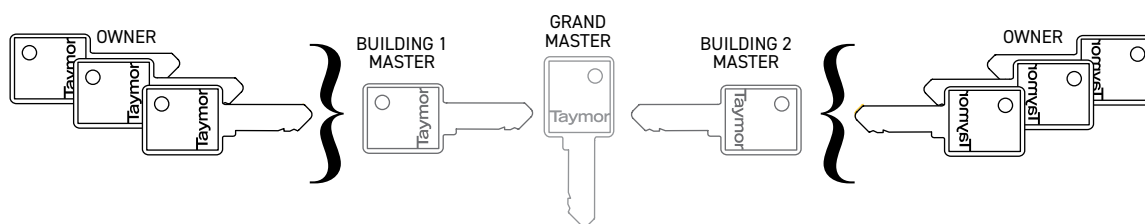

**CONSTRUCTION KEYING (CK)** allows the contractor of a project full access during the construction period. Once the owner's key is inserted, operation by the initial construction key is permanently disabled.

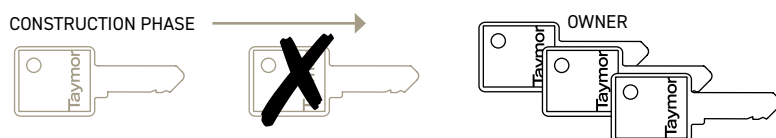

**DOUBLE KNOCKOUT CONSTRUCTION KEYING (CKRK)** adds a realtor key between the construction key and the owner key, which essentially allows a real estate professional to get temporary access until final handover to the buyer occurs. Once the owner's key is inserted, operation by the realtor key is permanently disabled.

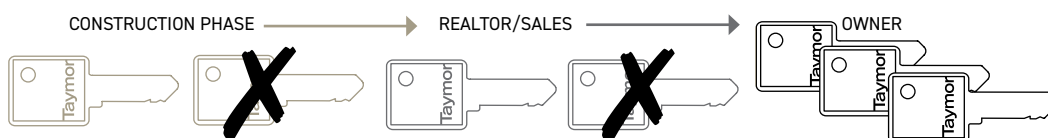

PARTS & SERVICES



# Escutcheon Etching

Add an escutcheon plate to entry doors as a decorative enhancement. Escutcheon plates can also be personalized with etching available for project orders.

\*MINIMUM QUANTITIES AND LEAD TIMES APPLY. PLEASE CONTACT TAYMOR FOR DETAILS.

## Escutcheon Plates

- › Decorative enhancement for entry door locks
- › Stainless steel material

	SATIN NICKEL 15		POLISHED CHROME 26		SATIN CHROME 26D	
Square 2 holes - 10"H x 3"W (254 mm x 76 mm) Both holes 2-1/8" (54 mm) DIA., 6" (152 mm) C/C	33-SN602	<b>\$56.98</b>	33-PC602	<b>\$51.53</b>	33-SC602	<b>\$51.53</b>
Square 2 holes - 10"H x 3"W (254 mm x 76 mm) Both holes 2-1/8" (54 mm) DIA., 5-1/2" (140 mm) C/C	33-SN502	<b>\$56.98</b>	33-PC502	<b>\$51.53</b>	33-SC502	<b>\$51.53</b>

CASE QTY. 50



## KEYING SERVICES & ACCESSORIES

FIRE CAN		
Must be ordered with compatible lock		
Fire can – for 20 minute fire rating	33-FIRECAN	<b>\$16.06</b>

KEYING OPTIONS		
Keyed alike	33-KA	<b>\$7.88</b>
Keyed different	33-KD	<b>\$7.88</b>
Master keying	33-MSTRKEY	<b>\$15.60</b>
Construction keying	33-CONSKEY	<b>\$21.04</b>
Construction/realtor keying	33-CONSKEY2	<b>\$21.62</b>
Master/construction keying	33-MCKKEY	<b>\$21.04</b>
Master/realtor/construction keying	33-MCKKEY2	<b>\$21.62</b>
Grand master keying	33-GMSTRGMK	<b>\$21.98</b>
Great grand master keying	33-GGMSTRMK	<b>\$31.79</b>
Grand master construction keying	33-GMCKEY	<b>\$19.95</b>

\*KEYING IDENTIFIER RING COLORS AVAILABLE

KEY CUTTING CODES		
Cut great grand master key	33-KCGGMK	<b>\$7.88</b>
Cut grand master key	33-KCGMK	<b>\$7.88</b>
Cut master key	33-KCMK	<b>\$7.88</b>
Stamp "DO NOT COPY" to be applied to all master keys	33-DNCKEY	<b>\$2.33</b>
Cut construction key	33-KCCK	<b>\$7.88</b>
Cut sales key	33-KCSA	<b>\$7.88</b>
Cut deficiency key	33-KCDK	<b>\$7.88</b>
Cut tenant access key	33-KCTA	<b>\$7.88</b>
Cut service key	33-KCSER	<b>\$7.88</b>
Cut amenity key	33-KCAM	<b>\$7.88</b>
Cut bike locker key	33-KCBK	<b>\$7.88</b>
Cut caretaker key	33-KCCT	<b>\$7.88</b>
Cut key commercial retail unit	33-KCCRU	<b>\$7.88</b>
Cut elevator key	33-KCEL	<b>\$7.88</b>
Cut electrical key	33-KCELT	<b>\$7.88</b>
Cut garbage key	33-KCGB	<b>\$7.88</b>
Cut gas key	33-KCGA	<b>\$7.88</b>
Cut homeowner keys (2 keys)	33-KCHK	<b>\$15.59</b>
Cut janitor key	33-KCJA	<b>\$7.88</b>
Cut mechanical key	33-KCME	<b>\$7.88</b>
Cut storage/locker key	33-KCST	<b>\$7.88</b>
Cut key use as generic tag with memo as to type	33-KC	<b>\$7.88</b>
Cut office key	33-KCOF	<b>\$7.88</b>
Cut Communication key	33-KCCU	<b>\$7.88</b>
Key and/or cylinder face stamping	33-STAMP	<b>\$5.18</b>

KEY BLANKS				
WR	5-PIN (WR5)		6-PIN (WR6)	
Large Taymor key blank	33-KEYWR5	<b>\$7.58</b>	—	
Silver	33-PB9201	<b>\$2.69</b>	—	
SC	5-PIN (SC1)		6-PIN (SC4)	
Large Taymor key blank	33-KEYSC1	<b>\$7.58</b>	33-KEYSC4	<b>\$7.58</b>
Silver	32-SCKB2	<b>\$2.24</b>	32-SC4	<b>\$2.24</b>

KEYING KITS				
	WR5		SC4	
Keying kit contains assorted pins, springs, circlips & tools needed for servicing	33-KK9302	<b>\$445.65</b>	32-TMKIT	<b>\$456.34</b>
Ball Bearings CROSS FLOW/PACE LINE (100 pc/pkg)	33-9360	<b>\$19.62</b>		
Ball Bearing Spring CROSS FLOW/PACE LINE (100 pc/pkg)	33-9361	<b>\$19.62</b>		

KEYING ACCESSORIES	WR5	SC4	
Universal top pin	33-9820	<b>\$19.62</b>	—
Master middle pin #2	33-9802	<b>\$19.62</b>	32-9322 <b>\$20.08</b>
Master middle pin #3	33-9803	<b>\$19.62</b>	32-9323 <b>\$20.08</b>
Master middle pin #4	33-9804	<b>\$19.62</b>	32-9324 <b>\$20.08</b>
Master middle pin #5	33-9805	<b>\$19.62</b>	32-9325 <b>\$20.08</b>
Master middle pin #6	33-9806	<b>\$19.62</b>	32-9326 <b>\$20.08</b>
Master middle pin #7	33-9807	<b>\$19.62</b>	32-9327 <b>\$20.08</b>
Master middle pin #8	33-9808	<b>\$19.62</b>	32-9328 <b>\$20.08</b>
Bottom pin #0	33-9810	<b>\$19.62</b>	32-9310 <b>\$20.08</b>
Bottom pin #1	33-9811	<b>\$19.62</b>	32-9311 <b>\$20.08</b>
Bottom pin #2	33-9812	<b>\$19.62</b>	32-9312 <b>\$20.08</b>
Bottom pin #3	33-9813	<b>\$19.62</b>	32-9313 <b>\$20.08</b>
Bottom pin #4	33-9814	<b>\$19.62</b>	32-9314 <b>\$20.08</b>
Bottom pin #5	33-9815	<b>\$19.62</b>	32-9315 <b>\$20.08</b>
Bottom pin #6	33-9816	<b>\$19.62</b>	32-9316 <b>\$20.08</b>
Bottom pin #7	33-9817	<b>\$19.62</b>	32-9317 <b>\$20.08</b>
Bottom pin #8	33-9818	<b>\$19.62</b>	32-9318 <b>\$20.08</b>
Bottom pin #9	33-9819	<b>\$19.62</b>	32-9319 <b>\$20.08</b>
C.K. ball bearing (construction key)	33-9330	<b>\$19.62</b>	—
Lockset plug clip	33-9351	<b>\$52.51</b>	—
Plug follower	33-9371	<b>\$16.79</b>	—
Clip remover	33-9381	<b>\$5.20</b>	—
Cylinder cap tool 14 tooth – for SC keyways	33-9375	<b>\$40.59</b>	—
Cylinder cap tool 12 tooth – for WR keyways	33-9375W	<b>\$40.59</b>	—
Universal Cylinder cap tool	33-9375ALL	<b>\$36.37</b>	33-9375ALL <b>\$36.37</b>



SC4 KEYS



WR5 KEYS



LARGE TAYMOR KEY BLANK



FIRE CAN



KEYING KIT

Strikes

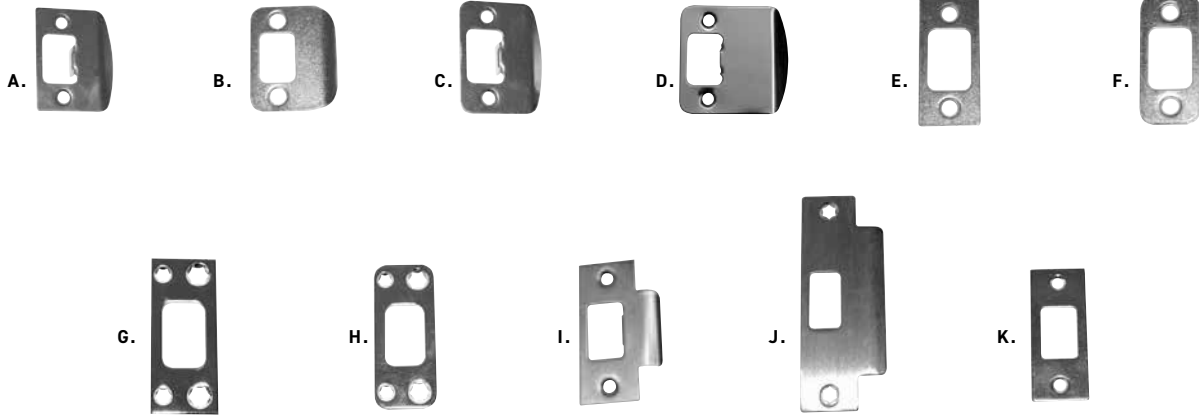

	POLISHED BRASS 3	AGED BRONZE 10B+	MATTE BLACK 19	POLISHED CHROME 26	STAINLESS STEEL 32D	
A. Strike square corner full lip adjustable tab 1-3/4" x 2-1/4"	33-PB9102AT	33-ORB9102AT	—	—	33-SS9102AT	<b>\$7.58</b>
B. Strike 1/4" radius corner full lip 1-3/4" x 2-1/4"	34-PB9117	—	—	—	—	<b>\$7.58</b>
C. Strike 1/4" radius corner full lip adjustable tab 1-3/4" x 2-1/4"	—	—	33-BLK9103AT	—	33-SS9103AT	<b>\$7.58</b>
D. Extended lip strike 1/4" radius corner full lip adjustable tab 2-1/4" x 2-1/4"	—	—	33-BLK9105AT	33-PC9105AT	33-SS9105AT	<b>\$16.41</b>
E. Strike rectangle square corner deadbolt 1" x 2-1/4"	33-PB9112	—	—	—	—	<b>\$7.58</b>
F. Strike 1/4" radius corner deadbolt 1" x 2-1/4"	33-PB9113	—	—	—	—	<b>\$7.58</b>
G. Hi-security strike square corner 1-1/8" x 2-3/4" w/2 3" screws for deadbolt	34-9335	—	33-BLK9335	—	33-SS9335	<b>\$16.41</b>
H. Hi-security strike 1/4" radius corner 1-1/8" x 2-3/4" w/2 3" screws for deadbolt	33-9338	—	33-BLK9338	—	33-SS9338	<b>\$16.41</b>
I. *Strike T-type adjustable tab 1-1/8" x 2-3/4"	33-PB9101	33-ORB9101	—	—	33-SS9101	<b>\$7.58</b>
J. *ASA Strike 1-1/2" x 4-7/8" x 3/32"	34-PB9109	—	33-BLK9109	—	33-SS9109	<b>\$16.56</b>
K. *Strike rectangle square corner deadbolt 1-1/8" x 2-3/4"	33-PB9111	33-ORB9111	—	—	33-SS9111	<b>\$7.58</b>

\*FOR USE WITH PREMIER LEVERS WITH COMBO SCREWS INCLUDED WITH LEVER. STEEL FRAMES MAY NEED TO BE PRE-TAPPED.

PARTS & SERVICES

Latches



RESIDENTIAL	POLISHED BRASS 3	SATIN NICKEL 15	MATTE BLACK 19	POLISHED CHROME 26	SATIN STAINLESS STEEL 32D
<b>The Premier Line</b>					
D. 6-in-1 adjustable spring latch (privacy/passage)	—	—	33-BLK9082	<b>\$44.18</b>	33-SS9082 <b>\$44.18</b>
F. 6-in-1 adjustable deadbolt	—	—	33-BLK9088	<b>\$44.18</b>	33-SS9088 <b>\$44.18</b>
I. 6-in-1 fixed handleset spring latch for London	—	—	33-BLK1085	<b>\$44.18</b>	33-SS1085 <b>\$44.18</b>
G. 6-in-1 adjustable deadbolt FLUSH FACED DEADBOLT ONLY	—	—	33-BLK9088	<b>\$44.18</b>	33-SS9088 <b>\$44.18</b>
<b>Professional Series® / Professional Select</b>					
A. 6-in-1 adjustable lever deadlatch (entry) CROSS FLOW & PACE LINE ONLY	—	33-SN9086 <b>\$44.18</b>	33-BLK9086 <b>\$44.18</b>	33-PC9086 <b>\$44.18</b>	—
B. 6-in-1 adjustable lever spring latch (privacy/passage) CROSS FLOW & PACE LINE ONLY	—	33-SN9087 <b>\$44.18</b>	33-BLK9087 <b>\$44.18</b>	33-PC9087 <b>\$44.18</b>	—
C. 6-in-1 adjustable knob deadlatch (entry)	33-PB9080 <b>\$44.18</b>	—	33-BLK9080 <b>\$44.18</b>	—	33-SS9080 <b>\$44.18</b>
C. 6-in-1 adjustable lever deadlatch (entry)	33-PB9083 <b>\$44.18</b>	—	33-BLK9083 <b>\$44.18</b>	—	33-SS9083 <b>\$44.18</b>
D. 6-in-1 adjustable knob spring latch (privacy/passage)	33-PB9081 <b>\$44.18</b>	—	33-BLK9081 <b>\$44.18</b>	—	33-SS9081 <b>\$44.18</b>
D. 6-in-1 adjustable lever spring latch (privacy/passage)	33-PB9082 <b>\$44.18</b>	—	33-BLK9082 <b>\$44.18</b>	—	33-SS9082 <b>\$44.18</b>
F. 6-in-1 adjustable deadbolt	33-PB9084 <b>\$44.18</b>	—	33-BLK9084 <b>\$44.18</b>	—	33-SS9084 <b>\$44.18</b>
I. 6-in-1 fixed handleset spring latch	33-PB9085 <b>\$44.18</b>	—	33-BLK9085 <b>\$44.18</b>	—	33-SS9085 <b>\$44.18</b>
<b>Builders Series/Proset® Series</b>					
C. 6-in-1 adjustable lever/knob deadlatch (entry)	33-PB9080 <b>\$44.18</b>	—	33-BLK9080 <b>\$44.18</b>	—	33-SS9080 <b>\$44.18</b>
D. 6-in-1 adjustable lever/knob spring latch (privacy/passage)	33-PB9081 <b>\$44.18</b>	—	33-BLK9081 <b>\$44.18</b>	—	33-SS9081 <b>\$44.18</b>
F. 6-in-1 adjustable deadbolt latch	33-PB9084 <b>\$44.18</b>	—	33-BLK9084 <b>\$44.18</b>	—	33-SS9084 <b>\$44.18</b>
<b>Other</b>					
E. 5" (127 mm) backset square mortise deadlatch (entry)*	—	—	—	—	33-SS9098 <b>\$44.18</b>
H. 5" (127 mm) backset square mortise deadbolt latch*	—	—	—	—	33-SS9099 <b>\$44.18</b>
J. Interconnected spring latch	—	—	—	—	33-SS3HRLATCHIC <b>\$50.49</b>
CASE QTY. 100 *COMPATIBLE WITH PROFESSIONAL® KNOBS AND BUILDERS SERIES LEVERS					

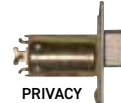
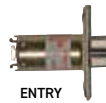

COMMERCIAL

3/4" (19 mm) BACKSET LATCHES FOR KNIGHT, YORK & CITADEL

Grade 1 – c-UL rated – 3/4" (19 mm) projection, 1-1/8" x 2-1/4" (28 mm x 57 mm) latch face (Required for fire rated double doors)	32-SSDBLDRDLATCH	<b>\$245.67</b>
---	------------------	-----------------

LATCHES FOR YORK & CITADEL

2-3/4" (70 mm) entry/keyed models 1-1/8" x 2-1/4" (28 mm x 57 mm) latch face, non-kick off	32-SS9060	<b>\$49.56</b>
2-3/8" (60mm) entry/keyed models 1" x 2-1/4" (25 mm x 57 mm) latch face, non-kick off	32-SS9061	<b>\$47.29</b>
2-3/8" (60mm) for privacy models 1" x 2-1/4" (25 mm x 57 mm) latch face, kick off	32-SS9064	<b>\$49.95</b>
2-3/4" (70mm) for passage models 1-1/8" x 2-1/4" (28 mm x 57 mm) latch face, non-kick off	32-SS9065	<b>\$49.56</b>
2-3/8" (60mm) for passage models 1" x 2-1/4" (25 mm x 57 mm) latch face, non-kick off	32-SS9066	<b>\$49.90</b>

LATCHES FOR KNIGHT

2-3/8" (60 mm) backset entry/keyed models 1" x 2-1/4" (25 mm x 57 mm) latch face, non-kick off	32-SS9067	<b>\$51.07</b>
2-3/8" (60 mm) backset privacy/keyed models 1" x 2-1/4" (25 mm x 57 mm) latch face, non-kick off	32-SS9068	<b>\$51.07</b>
2-3/8" (60 mm) backset passage/keyed models 1" x 2-1/4" (25 mm x 57 mm) latch face, non-kick off	32-SS9069	<b>\$51.07</b>

LATCHES FOR DUKE & EXCALIBUR

2-3/8" (60 mm) entry/keyed models 1" x 2-1/4" (25 mm x 57 mm) latch face, non-kick off	32-ELR79	<b>\$49.12</b>
2-3/4" (70 mm) for privacy/passage models 1-1/8" x 2-1/4" (28 mm x 57 mm) latch face, kick off	32-PLR794	<b>\$48.38</b>
2-3/8" (60 mm) for privacy/passage models 1" x 2-1/4" (25 mm x 57 mm) latch face, kick off	32-PLR79	<b>\$48.91</b>

LATCHES FOR DEADBOLTS (UL/c-UL 3 hour)

2-3/8" square mortise latch (for grade 1 deadbolts)	32-DBT80	<b>\$67.85</b>
2-3/4" square mortise latch (for grade 1 deadbolts)	32-DBT804	<b>\$67.85</b>

## Handleset Dummy Kits

### THE PREMIER LINE DUMMY HANDLESET

	ROUND		SQUARE	
AGED BRONZE 10+	30-BL1062BRN	<b>\$48.15</b>	30-BL1064BRN	<b>\$50.76</b>
SATIN NICKEL 15	30-BL1062SN	<b>\$48.15</b>	30-BL1064SN	<b>\$50.76</b>
MATTE BLACK 19	30-BL1062BLK	<b>\$48.15</b>	30-BL1064BLK	<b>\$50.76</b>
POLISHED CHROME 26	30-BL1062PC	<b>\$48.15</b>	30-BL1064PC	<b>\$50.76</b>
SATIN CHROME 26D	30-BL1062SC	<b>\$48.15</b>	30-BL1064SC	<b>\$50.76</b>

### PROFESSIONAL SERIES® DUMMY HANDLESET KIT

AGED BRONZE 10B+		33-BL805ORB	<b>\$27.88</b>
SATIN NICKEL 15		33-BL805SN	<b>\$27.88</b>
ANTIQUE NICKEL 17A		33-BL805AN	<b>\$27.88</b>
MATTE BLACK 19		33-BL805BLK	<b>\$27.88</b>
POLISHED CHROME 26		33-BL805PC	<b>\$27.88</b>
SATIN CHROME 26D		33-BL805SC	<b>\$27.88</b>

## Deadbolt Trim Kits

### THE PREMIER LINE & PROFESSIONAL SERIES® DEADBOLT INTERIOR TRIM KIT

	SQUARE		ROUND	
AGED BRONZE 10+	30-HDB1042BRN	<b>\$35.93</b>	30-HDB1044BRN	<b>\$32.33</b>
SATIN NICKEL 15	30-HDB1042SN	<b>\$32.53</b>	30-HDB1044SN	<b>\$29.53</b>
MATTE BLACK 19	30-HDB1042BLK	<b>\$32.53</b>	30-HDB1044BLK	<b>\$29.53</b>
POLISHED CHROME 26	30-HDB1042PC	<b>\$32.53</b>	30-HDB1044PC	<b>\$29.53</b>
SATIN CHROME 26D	30-HDB1042SC	<b>\$32.53</b>	30-HDB1044SC	<b>\$29.53</b>

SQUARE ROSE MUST BE ORDERED SEPARATELY FOR LEVER OR KNOB TRIM



## Extension Kits

### RESIDENTIAL

2-1/4" (57 mm) DOOR EXTENSION KITS	ASHFORD	STRAIT	MADERA	LONDON	PREMIER LEVER
POLISHED BRASS 3	—	—	33-WIDMADPB <b>\$36.07</b>	—	—
MATTE BLACK 19	33-WIDASHBLK <b>\$36.07</b>	—	33-WIDMADBLK <b>\$36.07</b>	—	—
POLISHED CHROME 26	33-WIDASHPC <b>\$36.07</b>	33-WIDSTRPC <b>\$36.07</b>	33-WIDMADPC <b>\$36.07</b>	30-ACTUATOR <b>\$35.73</b>	30-LEVEXT <b>\$6.40</b>

### COMMERCIAL

#### EXTENSION LINK for grade 2 - 3 hour fire rated locks & levers

35 mm - for 3-3/4" (95 mm) backset   Citadel & York trim	32-LE3595	<b>\$31.47</b>
57 mm - for 5" (127 mm) backset   Citadel & York trim	32-LE57127	<b>\$35.38</b>
57 mm - for 5" (127 mm) backset   Duke trim	32-LE127	<b>\$26.01</b>

## Actuators

HANDLESET ACTUATOR	ASHFORD	STRAIT	MADERA	LONDON	
33-ACTUATORA	—	—	✓	—	<b>\$36.07</b>
33-ACTUATORB	✓	✓	✓	—	<b>\$36.07</b>
33-ACTUATORC	—	—	—	✓	<b>\$36.07</b>

## Screw Packs

	POLISHED BRASS 3	AGED BRONZE 10B+	ANTIQUÉ NICKEL 17A	MATTE BLACK 19	BLACK	POLISHED CHROME 26	SATIN STAINLESS STEEL 32D	
Latch/strike combination screw pack	—	33-ORB9406	—	—	—	—	—	<b>\$0.36</b>
Professional Series® screw pack	—	—	—	—	—	33-9431PC	—	<b>\$4.14</b>
Professional Select screw pack (entry) CROSS FLOW & PACE LINE ONLY	—	—	—	33-9433BLK	—	—	33-9433SS	<b>\$4.14</b>
Professional Select® screw pack (privacy/passage) CROSS FLOW & PACE LINE ONLY	—	—	—	33-9434BLK	—	—	33-9434SS	<b>\$4.14</b>
The Premier Line screw pack	—	—	—	—	—	33-9441PC	—	<b>\$4.14</b>
London handleset screw pack	—	—	—	30-1023BLK	—	—	30-1023SSS	<b>\$9.77</b>
Single cylinder deadbolts screw pack	33-9423	33-9423ORB	—	—	—	—	33-9423SS	<b>\$5.71</b>
The Premier Line deadbolt screw pack	—	—	—	30-160BLK	—	—	30-160SSS	<b>\$5.81</b>
3" wood screws	—	—	—	33-9339BLK	—	33-9339AL	—	<b>\$4.25</b>

## Miscellaneous

	POLISHED BRASS 3	AGED BRONZE 10B+	ANTIQUÉ NICKEL 17A	MATTE BLACK 19	BLACK	POLISHED CHROME 26	SATIN STAINLESS STEEL 32D	
The Premier Line double dummy fastening kit	—	—	—	—	—	—	31-SSDDPREMIER	<b>\$10.32</b>
3" (76 mm) threaded bolt for double dummy	33-DDBOLT	—	—	—	—	—	—	<b>\$3.58</b>
Handleset concealed trim washer & plate	33-9342PB	33-9342BRN	33-9342AN	33-9342BLK	—	33-9342PC	33-9342SS	<b>\$4.60</b>
Deadbolt gasket	—	—	—	—	33-GASKETDB	—	—	<b>\$5.35</b>
Handleset gasket	—	—	—	—	33-GASKETGRIP	—	—	<b>\$4.03</b>
1"-1-1/8" (25.4 mm-30 mm) latch liner	—	—	—	33-PL118	—	—	—	<b>\$0.97</b>

# Handleset Customization

Customize the styling of any Taymor Premier or Professional Series® handleset with deadbolt, lever or knob interior trim options, a matching square or round decorative rose, and multiple finishes to match your other Taymor locks or home décor.

**PLEASE NOTE:** *The Strait handleset shown below is for illustrative purposes only.*

## CUSTOMIZATION TIPS

- › Explore the catalogue to see all Premier and Professional Series® inside trim options
- › Coordinate the deadbolt interior trim with the decorative rose style (square or round)
- › Match all interior trim finishes for a streamlined look



**OPTION 1**

Upgrade to the Premier deadbolt interior trim, select a square or round version.



INTERIOR SQUARE

INTERIOR ROUND

### PREMIER DEADBOLT INTERIOR TRIM

	SQUARE		ROUND	
AGED BRONZE 10+	30-HDB1042BRN	\$35.93	30-HDB1044BRN	\$32.33
SATIN NICKEL 15	30-HDB1042SN	\$32.53	30-HDB1044SN	\$29.53
MATTE BLACK 19	30-HDB1042BLK	\$32.53	30-HDB1044BLK	\$29.53
POLISHED CHROME 26	30-HDB1042PC	\$32.53	30-HDB1044PC	\$29.53
SATIN CHROME 26D	30-HDB1042SC	\$32.53	30-HDB1044SC	\$29.53

COMPATIBLE WITH PREMIER & PROFESSIONAL SERIES® HANDLESETS WHEN INSTALLED ON 1-3/4" (45 mm) THICK DOORS



MANCHESTER INTERIOR TRIM



SCREW COVER

eg. ASHFORD HANDLESET pg. 71

**OPTION 2**

Change the Manchester interior trim to a Professional Select knob or lever of your choice.

**NOTE:** Professional Series® Cross Flow & Pace Line Levers are not compatible as inside trim



eg. VILLA KNOB pg. 71



eg. PROVENCE LEVER pg. 70

**PLEASE NOTE:**  
Explore the catalogue to see all inside trim options.

\*Use a passage where interior trim does not exist. Use Vega and Bergen where Pace Line and Cross Flow are required.

**OPTION 3** Change the decorative rose from round to square if you upgrade to a Premier interior trim. Consider coordinating with the deadbolt style and finish.



eg. STOCKHOLM LEVER



SQUARE ROSE



CUSTOM STYLING

Upgrade to a Premier knob or lever design.

**NOTE:** Professional Series® interior trim options do not work with Premier handlesets.



eg. BARCELONA KNOB pg. 55



eg. VEGA LEVER pg. 54

### SQUARE CONTEMPORARY ROSE KIT

	INSIDE TRIM	
AGED BRONZE 10B+	30-SQR0044BRN	\$9.77
SATIN NICKEL 15	30-SQR0044SN	\$7.32
MATTE BLACK 19	30-SQR0044BLK	\$7.32
POLISHED CHROME 26	30-SQR0044PC	\$7.32
SATIN CHROME 26D	30-SQR0044SC	\$7.32

### HANDLESET CONCEALED TRIM WASHER, SCREW & PLATE

	INSIDE TRIM	
POLISHED BRASS 3	33-9342PB	\$4.60
AGED BRONZE 10B+	33-9342BRN	\$4.60
ANTIQUE NICKEL 17A	33-9342AN	\$4.60
MATTE BLACK 19	33-9342BLK	\$4.60
POLISHED CHROME 26	33-9342PC	\$4.60
SATIN STAINLESS STEEL 32D	33-9342SS	\$4.60



### CHANGING INTERIOR TRIM FINISH?

SELECT SCREW COVER IN MATCHING FINISH.



# Fire Rating

**20 MINUTE FIRE RATING** - for Residential Locks that are fire rateable, denoted with  (excludes Interconnect and Mortise Locks that come 3-hour fire rated)  
- add **\$15.15** to the list price of the lock.

## HOW TO ORDER

- › Use the existing item code with the fire rating code that matches the product line
- › Product item code + fire rating code
- › Use the table below and examples to the right to create an item code for the item you would like to fire rate

PRODUCT LINE	PREMIER	PROFESSIONAL	BUILDERS
FIRE RATING CODE	FC	FC	UL

## EXAMPLES

### The Premier Line

- › Vega passage lever in matte black:  
30-D006434BLK+FC = 30-D006434BLKFC
- › Premier deadbolt in satin nickel:  
30-D01SC406SN+FC = 30-D01SC406SNFC

### Professional Series

- › Single cylinder deadbolt in satin nickel plate:  
33-D420+FC = 33-D420FC

### Builders Series

- › Orleans passage:  
36-RD3805SN+UL = 36-RD3805SNUL

# Finish Guides

THE PREMIER LINE	POLISHED BRASS 3	AGED BRONZE 10B+	SATIN NICKEL 15	ANTIQUE NICKEL 17A	MATTE BLACK 19	POLISHED CHROME 26	SATIN CHROME 26D	SATIN STAINLESS STEEL 32D
1948 lever	–	–	✓	–	✓	✓	–	–
Barcelona knob	–	–	✓	–	✓	–	–	–
Arc Deco lever	–	–	✓	–	✓	✓	–	–
Bergen lever	–	–	✓	–	✓	✓	✓	–
Britannia lever	–	✓	✓	–	–	✓	–	–
The Premier Line deadbolts	–	–	✓	–	✓	✓	✓	–
Equinox lever	–	–	✓	–	–	✓	✓	–
Full Bloom lever	–	–	✓	–	✓	✓	–	–
London handleset	–	–	✓	–	✓	✓	✓	–
Slip Stream lever	–	–	✓	–	✓	✓	–	–
Stockholm lever	–	–	✓	–	–	✓	–	–
Vega lever	–	–	✓	–	✓	✓	✓	–
✓AVAILABLE								

Professional Select	POLISHED BRASS 3	AGED BRONZE 10B+	SATIN NICKEL 15	ANTIQUE NICKEL 17A	MATTE BLACK 19	POLISHED CHROME 26	SATIN CHROME 26D	SATIN STAINLESS STEEL 32D
Cross Flow lever	–	–	✓	–	✓	✓	–	–
Free Style lever	–	–	✓	–	✓	✓	–	–
Leading Edge handleset	–	–	✓	–	✓	✓	–	–
Pace Line lever	–	–	✓	–	✓	✓	–	–
Ramp Up lever	–	–	✓	–	✓	✓	–	–
Professional Select Deadbolts	–	–	✓	–	✓	✓	–	–
✓AVAILABLE								

PROFESSIONAL SERIES®	POLISHED BRASS 3	AGED BRONZE 10B+	SATIN NICKEL 15	ANTIQUE NICKEL 17A	MATTE BLACK 19	POLISHED CHROME 26	SATIN CHROME 26D	SATIN STAINLESS STEEL 32D
Ashford handleset	–	✓	✓	–	✓	–	–	–
Bristol lever	–	–	✓	–	✓	–	–	–
Hampton lever	–	–	–	–	–	–	✓	✓
Madera handleset	✓	✓	✓	✓	✓	–	–	–
Manchester dome knob	–	✓	✓	–	–	–	–	–
Professional Series® deadbolt	✓	✓	✓	✓	✓	✓	✓	✓
Provence lever	–	✓	✓	✓	✓	–	–	–
Strait handleset	–	–	✓	–	✓	✓	✓	–
Villa ball knob	✓	–	✓	✓	✓	–	✓	✓
✓AVAILABLE								



**BATH**

**HARDWARE**

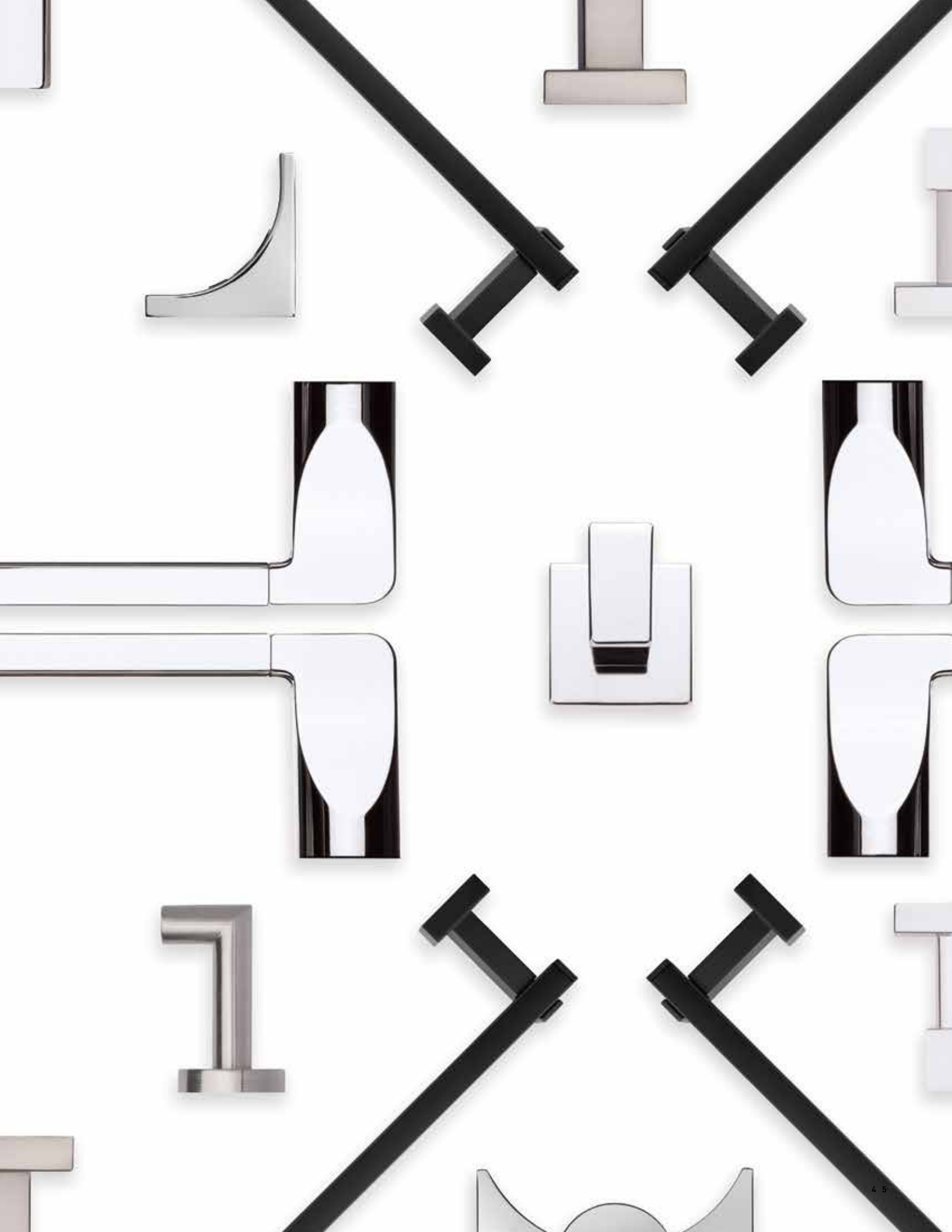



ARC DECO COLLECTION IN MATTE BLACK

## Bath Collections

Bring the look and experience of your bathroom design to life with our comprehensive portfolio of bath hardware. Crafted with a clean and modern sensibility our products are designed to fit your space and lifestyle. Create a cohesive and complete environment by coordinating Taymor locks with the timeless aesthetic and thoughtful detailing of Taymor bath collections.



ARC DECO TOWEL BAR IN MATTE BLACK

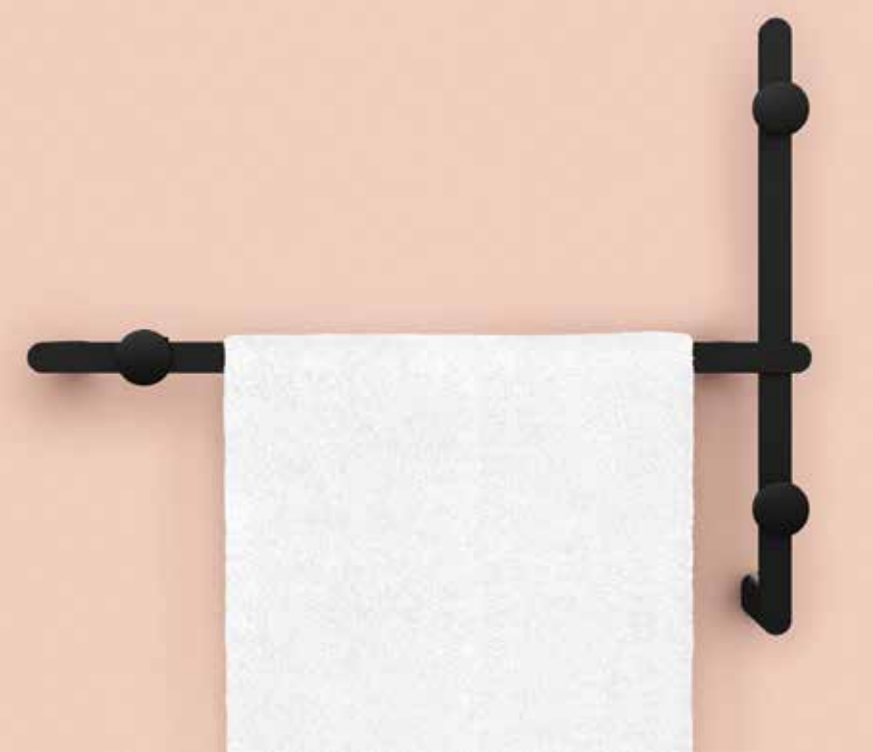

DUAL HARMONY TOWEL BAR, PAPER HOLDER & HAND TOWEL BAR IN MATTE BLACK

Dual Harmony **New!**

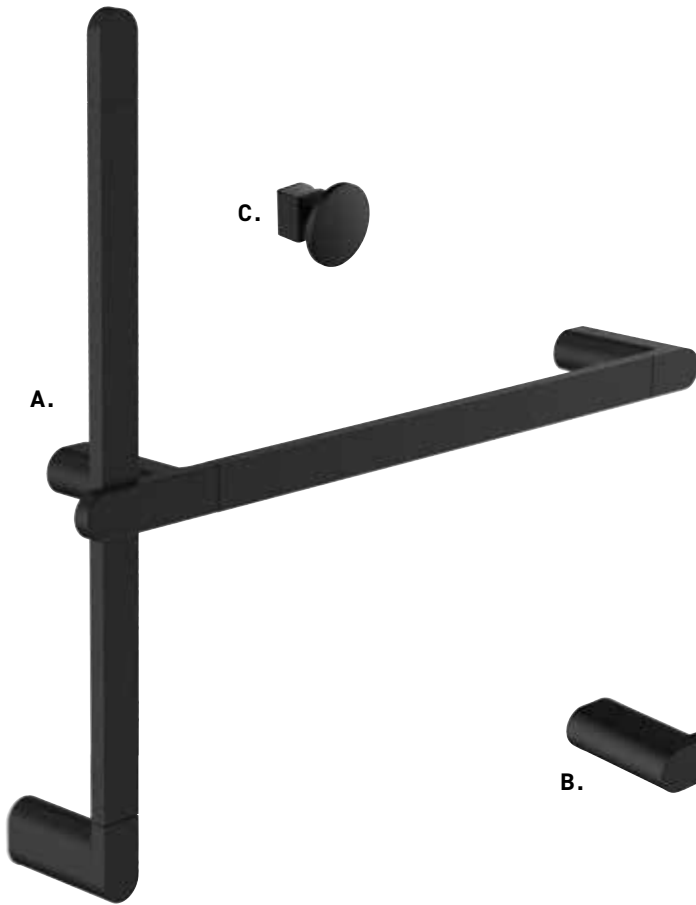



DUAL HARMONY TOWEL BAR IN POLISHED CHROME WITH TWO MATTE BLACK SINGLE MODULAR HOOKS



	MATTE BLACK 19		POLISHED CHROME 26		CASE QTY
A. TOWEL BAR - 16" LEFT POST BAR ILLUSTRATED	04-18016LBLK	<b>\$238.60</b>	04-18016L	<b>\$238.60</b>	4
TOWEL BAR - 16" RIGHT POST BAR NOT ILLUSTRATED	04-18016RBLK	<b>\$238.60</b>	04-18016R	<b>\$238.60</b>	4
TOWEL BAR - 22" LEFT POST BAR NOT ILLUSTRATED	04-18022LBLK	<b>\$261.29</b>	04-18022L	<b>\$261.29</b>	4
TOWEL BAR - 22" RIGHT POST BAR NOT ILLUSTRATED	04-18022RBLK	<b>\$261.29</b>	04-18022R	<b>\$261.29</b>	4
B. HAND TOWEL BAR	04-18010BLK	<b>\$98.64</b>	04-18010	<b>\$98.64</b>	4
C. SINGLE MODULAR HOOK	04-18001BLK	<b>\$56.45</b>	04-18001	<b>\$56.45</b>	8
D. PAPER HOLDER	04-18048BLK	<b>\$86.36</b>	04-18048	<b>\$86.36</b>	4



ARC DECO ROBE HOOK & TOWEL BAR IN MATTE BLACK

### Arc Deco

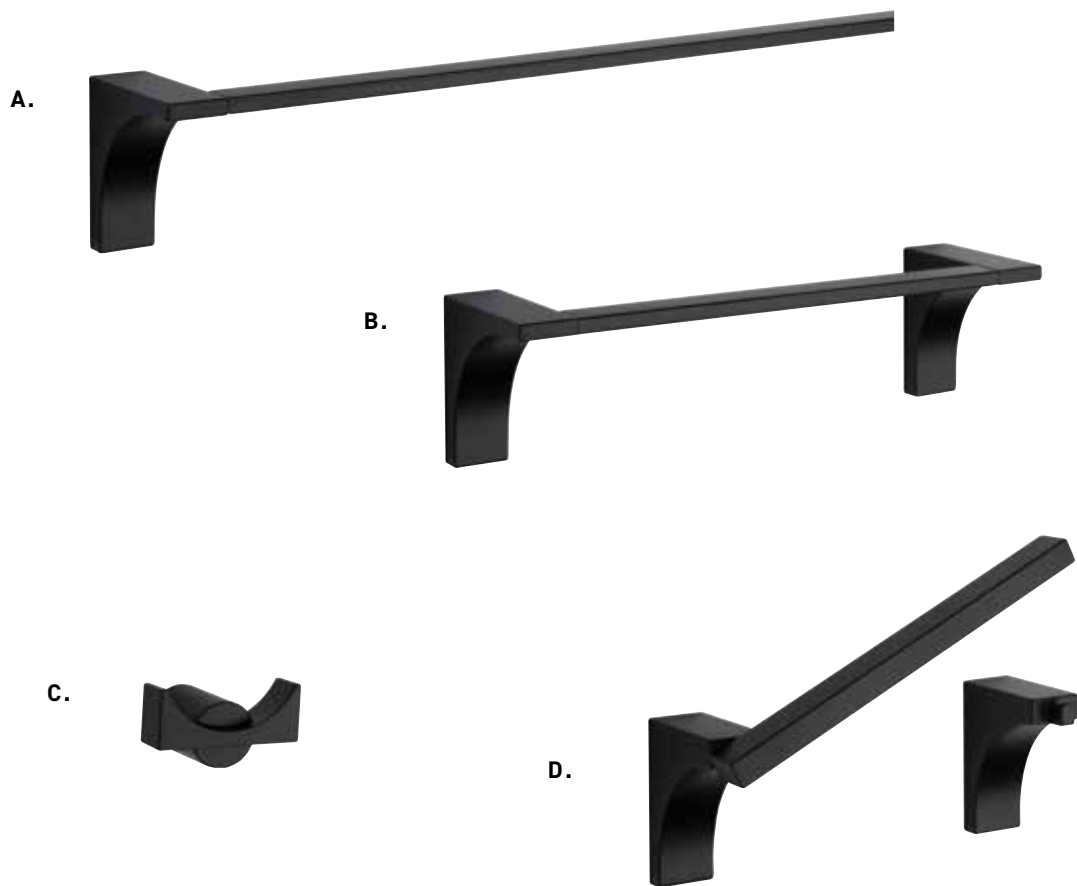





ARC DECO HAND TOWEL BAR IN POLISHED CHROME



BOX PACK	MATTE BLACK 19		POLISHED CHROME 26		CASE QTY
A. TOWEL BAR - 16"	04-17316BLK	<b>\$104.18</b>	04-17316	<b>\$104.18</b>	4
TOWEL BAR - 24"	04-17324BLK	<b>\$116.10</b>	04-17324	<b>\$116.10</b>	4
B. HAND TOWEL BAR	04-17309BLK	<b>\$ 87.02</b>	04-17309	<b>\$ 87.02</b>	4
C. DOUBLE ROBE HOOK	04-17302BLK	<b>\$ 57.44</b>	04-17302	<b>\$ 57.44</b>	4
D. PIVOTING PAPER HOLDER	04-17308PBLK	<b>\$ 79.73</b>	04-17308P	<b>\$ 79.73</b>	4

SEE PAGE 51 FOR COORDINATING LEVERS



SLIP STREAM TOWEL BAR IN MATTE BLACK

### Slip Stream

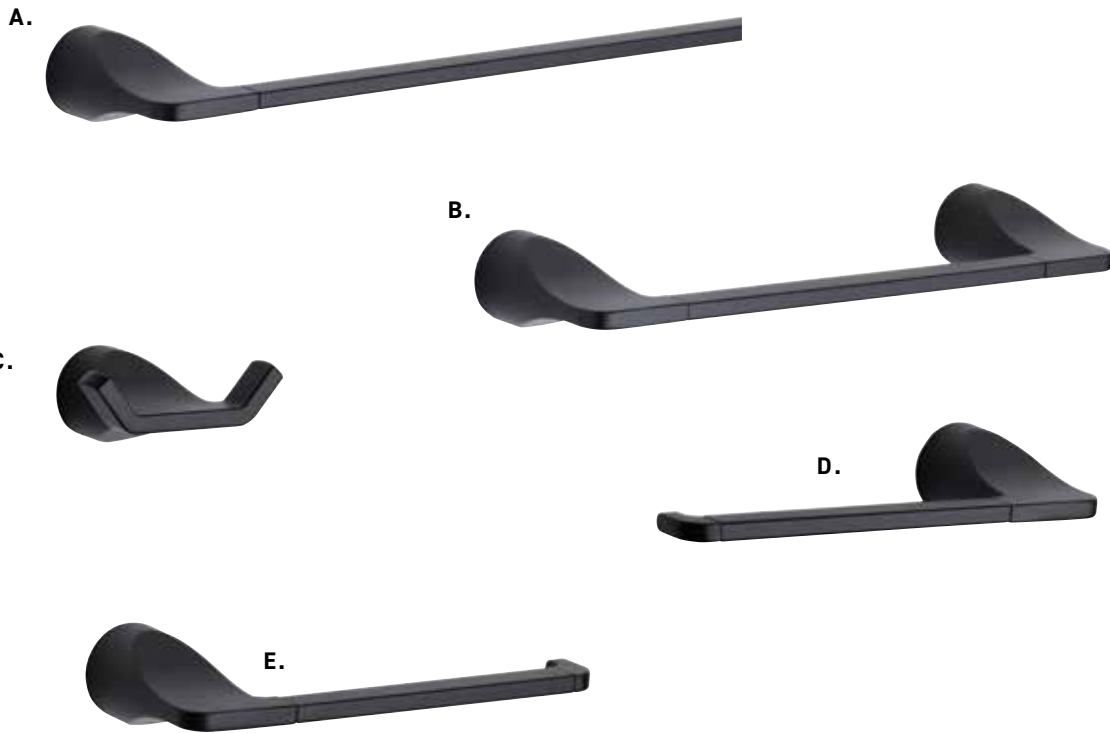



SLIP STREAM ROBE HOOK IN POLISHED CHROME

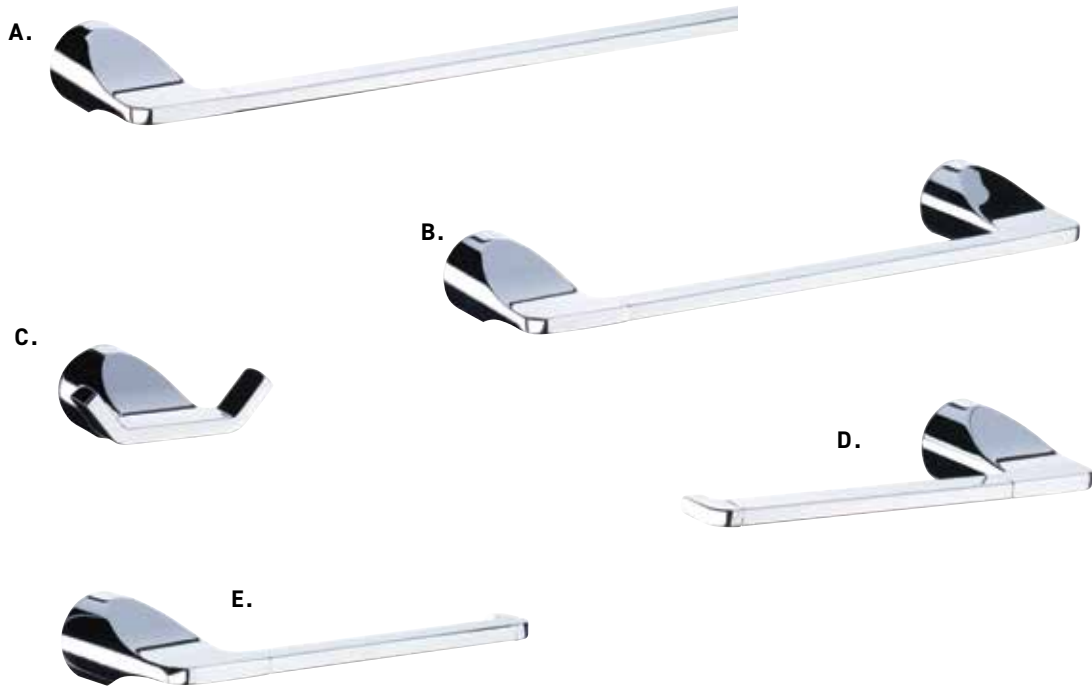

BOX PACK	MATTE BLACK 19		POLISHED CHROME 26		CASE QTY
A. TOWEL BAR - 16"	04-33416BLK	<b>\$101.51</b>	04-33416	<b>\$ 92.28</b>	10
TOWEL BAR - 24"	04-33424BLK	<b>\$112.90</b>	04-33424	<b>\$102.63</b>	10
B. HAND TOWEL BAR	04-33409BLK	<b>\$ 86.72</b>	04-33409	<b>\$ 78.83</b>	10
C. DOUBLE ROBE HOOK	04-33402BLK	<b>\$ 49.66</b>	04-33402	<b>\$ 45.16</b>	10
D. PAPER HOLDER - LEFT	04-33448LBLK	<b>\$ 73.13</b>	04-33448L	<b>\$ 66.47</b>	10
E. PAPER HOLDER - RIGHT	04-33448RBLK	<b>\$ 73.13</b>	04-33448R	<b>\$ 66.47</b>	10

SEE PAGE 52 FOR COORDINATING LEVERS



1948 ROUND DOUBLE ROBE HOOK AND TOWEL BAR IN POLISHED CHROME

**1948 Round**



BOX PACK	MATTE BLACK 19	POLISHED CHROME 26	CASE QTY
A. TOWEL BAR - 18"	04-32718BLK <b>\$165.51</b>	04-32718 <b>\$150.46</b>	10
TOWEL BAR - 24"	04-32724BLK <b>\$185.34</b>	04-32724 <b>\$167.34</b>	10
B. HAND TOWEL BAR	04-32710BLK <b>\$147.04</b>	04-32710 <b>\$133.87</b>	10
C. DOUBLE ROBE HOOK	04-32702BLK <b>\$ 66.07</b>	04-32702 <b>\$ 60.07</b>	10
D. PAPER HOLDER	04-32748BLK <b>\$119.53</b>	04-32748 <b>\$108.66</b>	10
E. TOWEL RING	04-32704BLK <b>\$118.04</b>	04-32704 <b>\$107.33</b>	10

SEE PAGE 53 FOR COORDINATING LEVERS



1948 SQUARE BATH COLLECTION IN MATTE BLACK

## 1948 Square

A.



B.



C.



D.

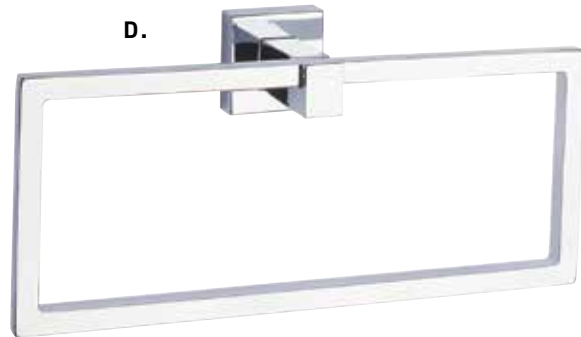

BOX PACK	MATTE BLACK 19		POLISHED CHROME 26		CASE QTY
A. TOWEL BAR - 18"	04-32818BLK	<b>\$147.19</b>	04-32818	<b>\$133.83</b>	10
TOWEL BAR - 24"	04-32824BLK	<b>\$163.55</b>	04-32824	<b>\$148.68</b>	10
TOWEL BAR - 30"	04-32830BLK	<b>\$188.10</b>	04-32830	<b>\$170.99</b>	10
B. DOUBLE ROBE HOOK	04-32802BLK	<b>\$ 66.53</b>	04-32802	<b>\$ 60.47</b>	10
C. PAPER HOLDER	04-32848BLK	<b>\$ 98.11</b>	04-32848	<b>\$ 89.20</b>	10
D. TOWEL RING	04-32804BLK	<b>\$108.90</b>	04-32804	<b>\$ 99.13</b>	10

SEE PAGE 53 FOR COORDINATING LEVERS



SUITE AND SIMPLE® DOUBLE TOWEL RING (LEFT), TOWEL RING (RIGHT) IN MATTE BLACK

Suite and Simple®



BOX PACK	MATTE BLACK 19	POLISHED CHROME 26	CASE QTY
A. TOWEL BAR - 18"	04-32918BLK <b>\$171.85</b>	04-32918 <b>\$156.22</b>	10
TOWEL BAR - 24"	04-32924BLK <b>\$190.95</b>	04-32924 <b>\$173.59</b>	10
B. DOUBLE ROBE HOOK	04-32902BLK <b>\$ 70.15</b>	04-32902 <b>\$ 63.77</b>	10
C. PAPER HOLDER	04-32948BLK <b>\$118.59</b>	04-32948 <b>\$107.81</b>	10
D. TOWEL RING	04-32904BLK <b>\$149.58</b>	04-32904 <b>\$135.96</b>	10
*E. DOUBLE TOWEL RING SPECIAL ORDER, SEE FACING PAGE	04-32907DBLK <b>\$312.10</b>	04-32907D <b>\$283.73</b>	5



BITTER SUITE ROBE HOOK AND TOWEL BAR IN POLISHED CHROME

**Bitter Suite**

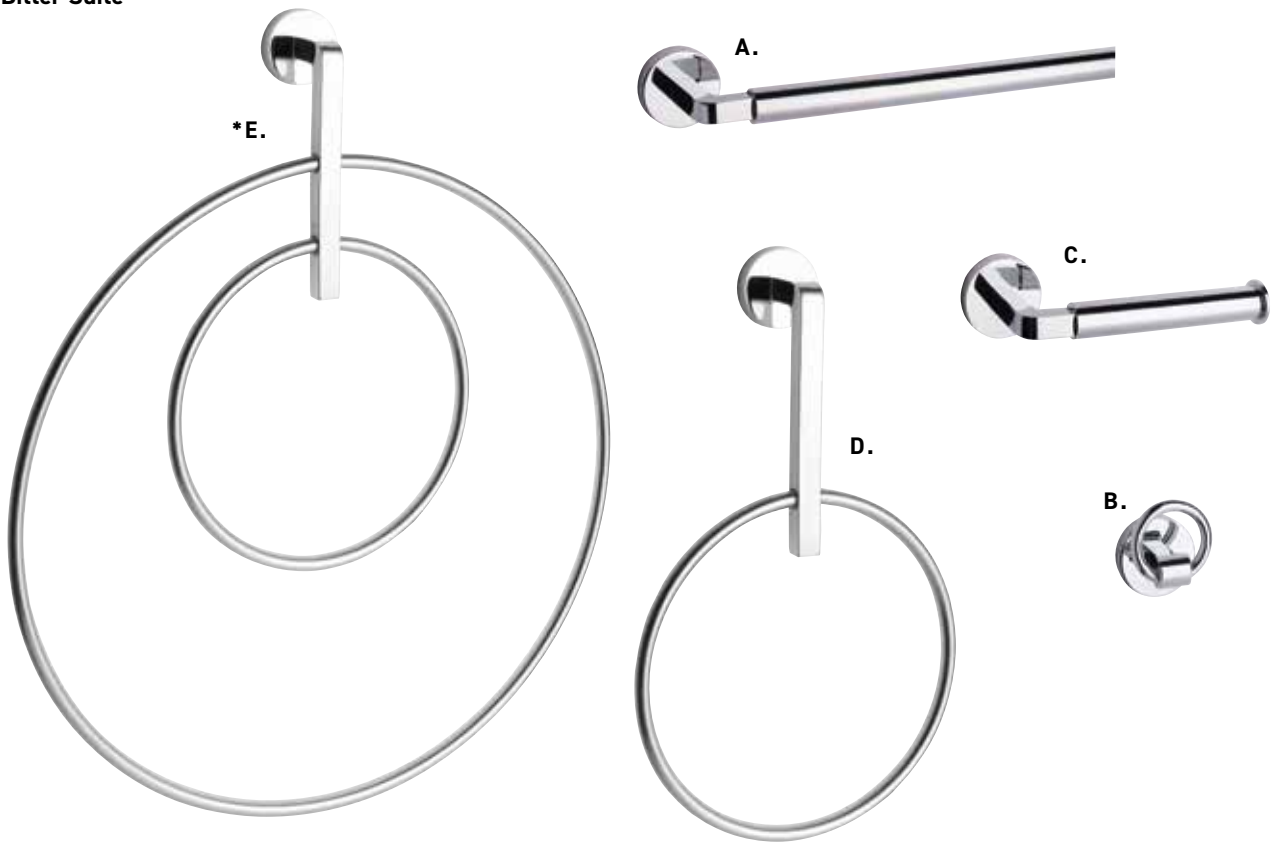

BOX PACK	POLISHED CHROME 26	CASE QTY
A. TOWEL BAR - 18"	04-33018 <b>\$152.49</b>	10
TOWEL BAR - 24"	04-33024 <b>\$169.43</b>	10
B. SINGLE ROBE HOOK	04-33001 <b>\$ 61.32</b>	10
C. PAPER HOLDER	04-33048 <b>\$104.86</b>	10
D. TOWEL RING	04-33004 <b>\$118.59</b>	10
*E. DOUBLE TOWEL RING SPECIAL ORDER, SEE BELOW	04-33007D <b>\$258.10</b>	5

**\*DOUBLE TOWEL RINGS**

**SPECIAL ORDER:** This product is available for project orders - minimum quantities and lead times apply. For quotes or assistance for multi-family residential projects, please contact our Customer Service team.

# THE COLLECTIONS

## Electra

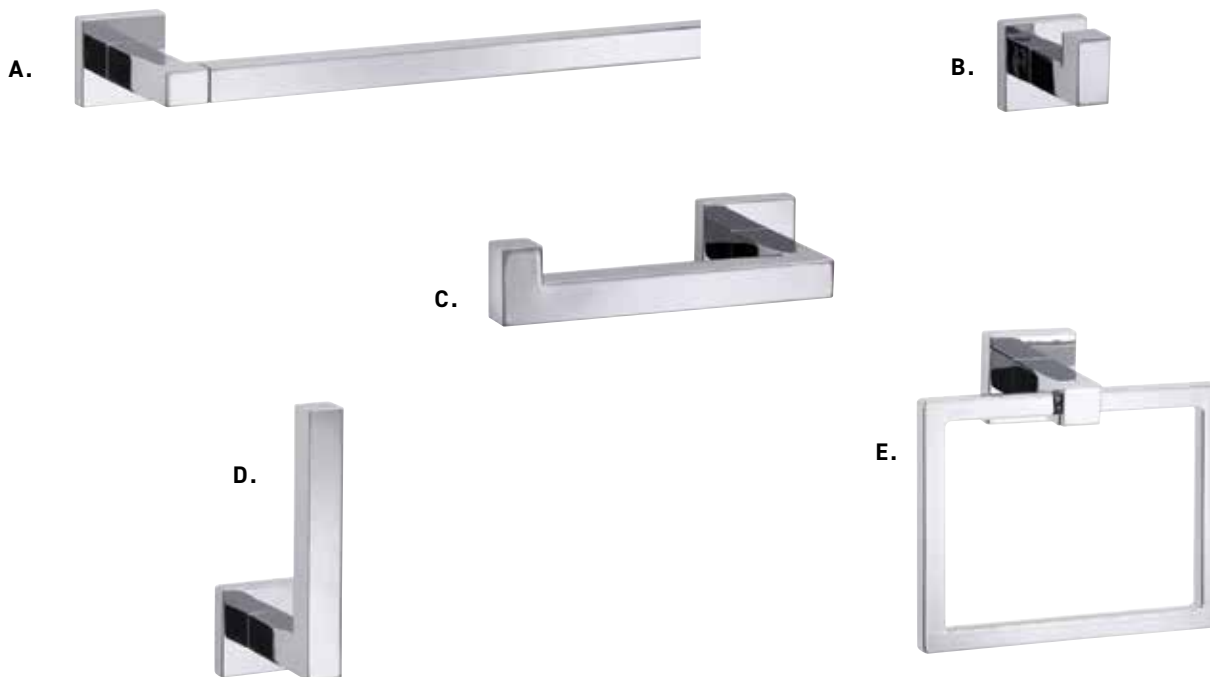

VISUAL PACK	SATIN NICKEL 15		POLISHED CHROME 26		CASE QTY.
A. TOWEL BAR - 18"	02-D2118SN	\$168.31	02-D2118	\$151.56	4
TOWEL BAR - 24"	02-D2124SN	\$187.01	02-D2124	\$168.39	4
B. SINGLE ROBE HOOK	02-D2101SN	\$ 51.42	02-D2101	\$ 43.68	4
C. PAPER HOLDER	02-D2148SN	\$ 95.01	02-D2148	\$ 89.99	4
D. VERTICAL PAPER HOLDER	02-D2158SN	\$ 95.01	02-D2158	\$ 89.99	4
E. TOWEL RING	02-D2104SN	\$ 83.20	02-D2104	\$ 66.49	4

BOX PACK				
A. TOWEL BAR - 18"	-	04-2118	\$151.56	10
TOWEL BAR - 24"	-	04-2124	\$168.39	10
B. SINGLE ROBE HOOK	-	04-2101	\$ 43.68	10
C. PAPER HOLDER	-	04-2148	\$ 89.99	10
D. VERTICAL PAPER HOLDER	-	04-2158	\$ 89.99	10
E. TOWEL RING	-	04-2104	\$ 66.49	10





ALLUSION TOWEL BAR IN MATTE BLACK (LEFT), POLISHED CHROME (RIGHT)

## Allusion

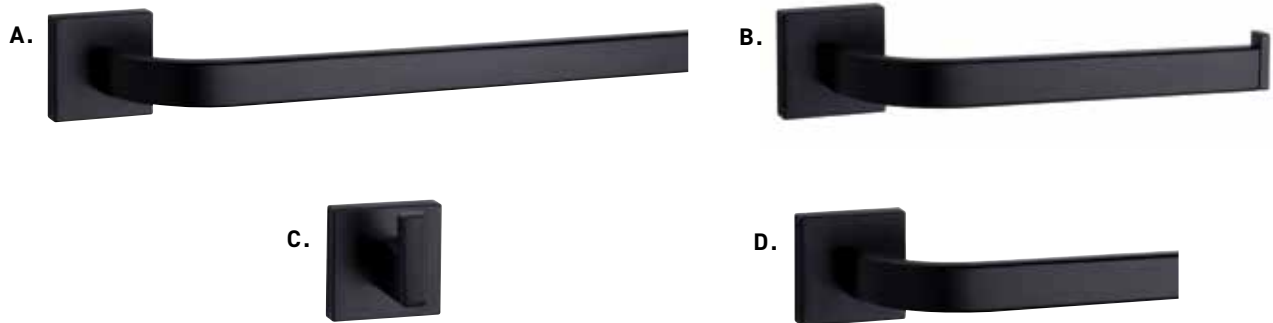

VISUAL PACK	MATTE BLACK 19	POLISHED CHROME 26	CASE QTY.
A. TOWEL BAR - 18"	02-D32518BLK <b>\$107.92</b>	02-D32518 <b>\$ 98.09</b>	4
TOWEL BAR - 24"	02-D32524BLK <b>\$114.37</b>	02-D32524 <b>\$103.96</b>	4
B. HAND TOWEL BAR	02-D32510BLK <b>\$ 79.85</b>	02-D32510 <b>\$ 72.59</b>	4
C. SINGLE ROBE HOOK	02-D32501BLK <b>\$ 49.64</b>	02-D32501 <b>\$ 45.13</b>	4
D. PAPER HOLDER	02-D32548BLK <b>\$ 70.98</b>	02-D32548 <b>\$ 64.53</b>	4

BOX PACK	MATTE BLACK 19	POLISHED CHROME 26	CASE QTY.
A. TOWEL BAR - 18"	04-32518BLK <b>\$107.92</b>	04-32518 <b>\$ 98.09</b>	10
TOWEL BAR - 24"	04-32524BLK <b>\$114.37</b>	04-32524 <b>\$103.96</b>	10
B. HAND TOWEL BAR	04-32510BLK <b>\$ 79.85</b>	04-32510 <b>\$ 72.59</b>	10
C. SINGLE ROBE HOOK	04-32501BLK <b>\$ 49.64</b>	04-32501 <b>\$ 45.13</b>	10
D. PAPER HOLDER	04-32548BLK <b>\$ 70.98</b>	04-32548 <b>\$ 64.53</b>	10



ASTRAL BATH COLLECTION IN MATTE BLACK

**Astral**

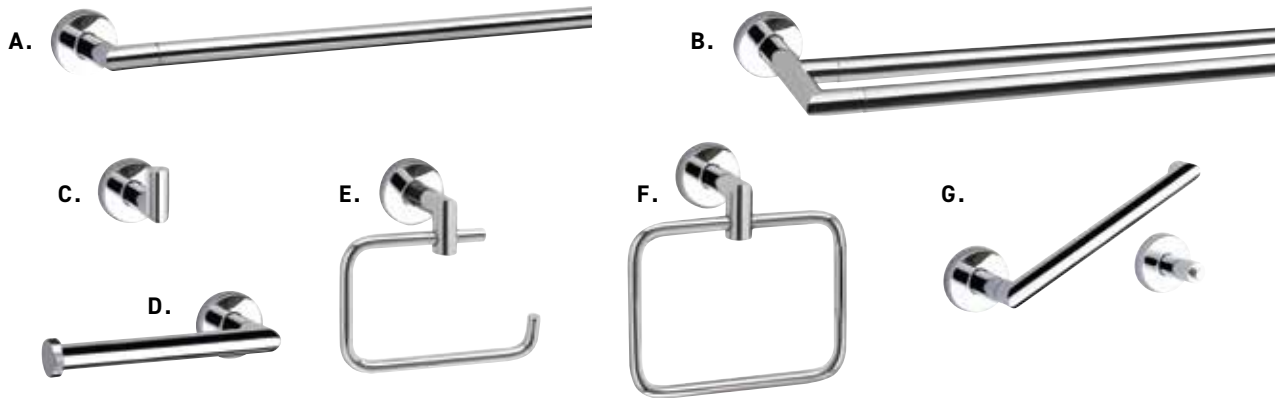

VISUAL PACK	SATIN NICKEL 15		MATTE BLACK 19		POLISHED CHROME 26		CASE QTY.
A. HAND TOWEL BAR	-		02-D2810BLK	\$ 91.71	-		4
TOWEL BAR - 18"	-		02-D2818BLK	\$ 99.68	02-D2818	\$ 87.66	4
TOWEL BAR - 24"	-		02-D2824BLK	\$110.76	02-D2824	\$ 97.40	4
TOWEL BAR - 30"	-		-		02-D2830	\$112.02	4
B. DOUBLE TOWEL BAR 24"	-		-		02-D2824D	\$154.05	4
C. SINGLE ROBE HOOK	-		02-D2801BLK	\$ 48.26	02-D2801	\$ 42.46	4
D. PAPER HOLDER	-		02-D2848BLK	\$ 63.54	02-D2848	\$ 63.36	4
E. PAPER HOLDER	-		-		02-D2838	\$ 63.36	4
F. TOWEL RING	-		-		02-D2804A	\$ 69.44	4
BOX PACK							
A. HAND TOWEL BAR	04-SN2810	\$ 91.71	04-2810BLK	\$ 91.71	04-2810	\$ 80.66	10
TOWEL BAR - 18"	04-SN2818	\$ 99.68	04-2818BLK	\$ 99.68	04-2818	\$ 87.66	10
TOWEL BAR - 24"	04-SN2824	\$110.76	04-2824BLK	\$110.76	04-2824	\$ 97.40	10
TOWEL BAR - 30"	04-SN2830	\$117.76	04-2830BLK	\$117.76	04-2830	\$104.21	10
C. SINGLE ROBE HOOK	04-SN2801	\$ 48.26	04-2801BLK	\$ 48.26	04-2801	\$ 42.46	10
D. PAPER HOLDER	04-SN2848	\$ 63.54	04-2848BLK	\$ 63.54	04-2848	\$ 63.36	10
E. PAPER HOLDER	04-SN2838	\$ 71.60	04-2838BLK	\$ 63.54	04-2838	\$ 63.36	10
F. TOWEL RING	04-SN2804A	\$ 73.66	04-2804ABLK	\$ 78.47	04-2804A	\$ 69.44	10
G. PIVOTING PAPER HOLDER	04-2808PSN	\$ 76.29	04-2808PBLK	\$ 76.29	04-2808P	\$ 76.00	10



WAVE TOWEL BAR IN POLISHED CHROME

**Wave**



VISUAL PACK	POLISHED CHROME 26	CASE QTY.
A. TOWEL BAR - 18"	02-D20518 <b>\$107.96</b>	4
TOWEL BAR - 24"	02-D20524 <b>\$119.95</b>	4
B. HAND TOWEL BAR	02-D20509 <b>\$ 76.35</b>	4
C. DOUBLE ROBE HOOK	02-D20502 <b>\$ 36.55</b>	4
D. PAPER HOLDER	02-D20548 <b>\$ 71.89</b>	4

## THE COLLECTIONS

### Qube

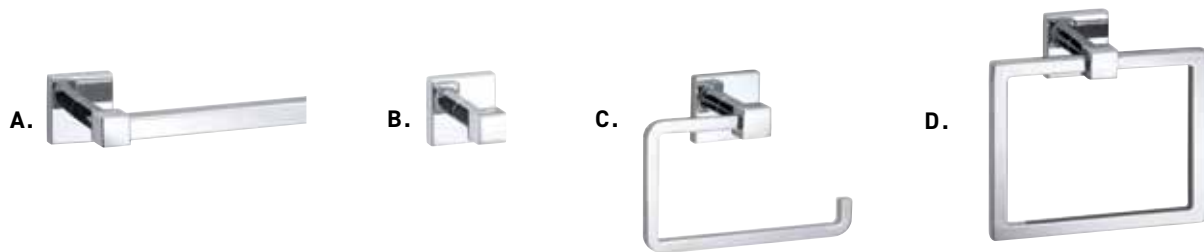

VISUAL PACK	POLISHED CHROME 26	CASE QTY.
A. TOWEL BAR - 18"	02-D2318 \$ <b>96.80</b>	4
TOWEL BAR - 24"	02-D2324 \$ <b>107.55</b>	4
B. SINGLE ROBE HOOK	02-D2301 \$ <b>35.12</b>	4
C. PAPER HOLDER	02-D2348 \$ <b>59.12</b>	4
D. TOWEL RING	02-D2304 \$ <b>67.62</b>	4

### Lund

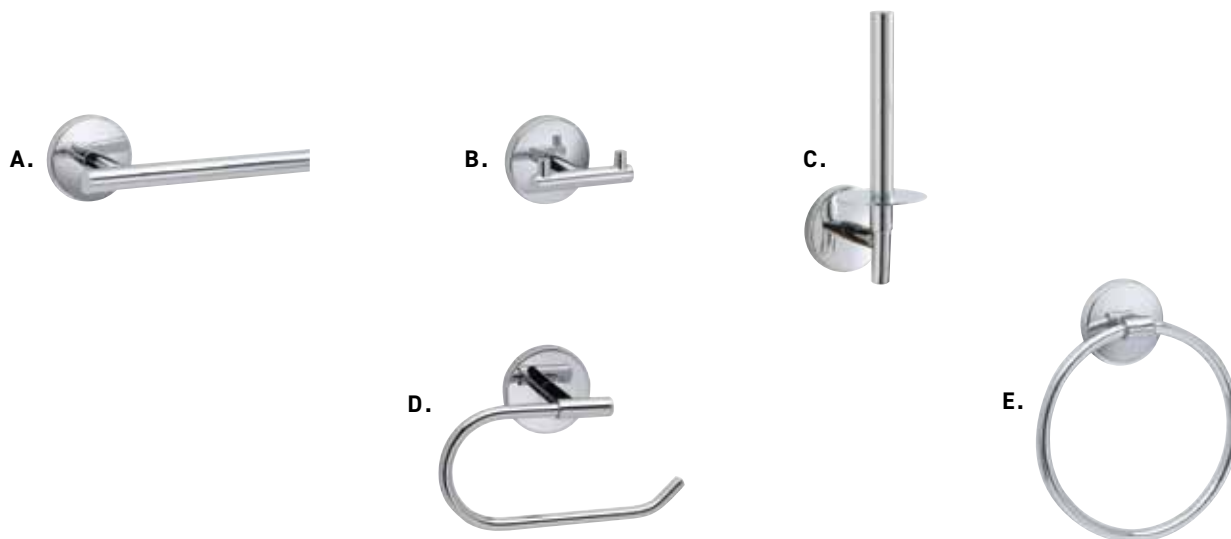

BOX PACK	POLISHED CHROME 26	CASE QTY.
A. TOWEL BAR - 18"	04-20818 \$ <b>91.98</b>	10
TOWEL BAR - 24"	04-20824 \$ <b>102.18</b>	10
B. DOUBLE ROBE HOOK	04-20802 \$ <b>41.57</b>	10
C. VERTICAL PAPER HOLDER	04-20858 \$ <b>65.37</b>	10
D. PAPER HOLDER	04-20838 \$ <b>65.37</b>	10
E. TOWEL RING	04-20804 \$ <b>58.89</b>	10

Naples

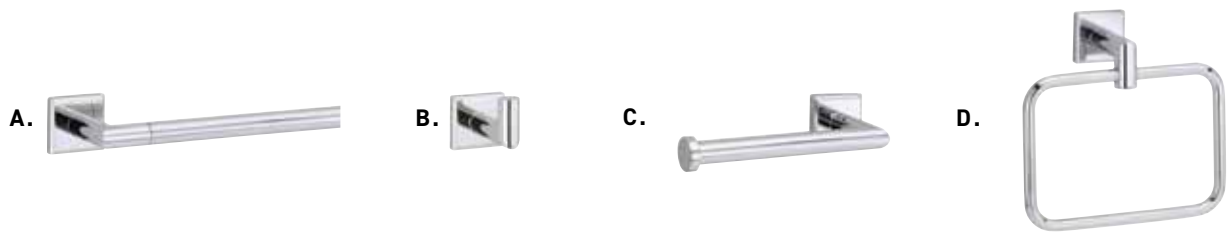

VISUAL PACK	SATIN NICKEL 15	MATTE BLACK 19	POLISHED CHROME 26	CASE QTY.
A. TOWEL BAR - 18"	02-D5518SN <b>\$104.30</b>	-	02-D5518 <b>\$ 90.70</b>	4
TOWEL BAR - 24"	02-D5524SN <b>\$115.90</b>	-	02-D5524 <b>\$100.76</b>	4
B. SINGLE ROBE HOOK	02-D5501SN <b>\$ 48.81</b>	-	02-D5501 <b>\$ 42.44</b>	4
C. PAPER HOLDER	02-D5548SN <b>\$ 72.99</b>	-	02-D5548 <b>\$ 63.47</b>	4
D. TOWEL RING	02-D5504SN <b>\$ 74.95</b>	-	02-D5504 <b>\$ 65.18</b>	4

Coming Soon!

BOX PACK	SATIN NICKEL 15	MATTE BLACK 19	POLISHED CHROME 26	CASE QTY.
A. TOWEL BAR - 18"	04-5518SN <b>\$104.30</b>	04-5518BLK <b>\$ 90.70</b>	04-5518 <b>\$ 90.70</b>	10
TOWEL BAR - 24"	04-5524SN <b>\$115.90</b>	04-5524BLK <b>\$100.76</b>	04-5524 <b>\$100.76</b>	10
TOWEL BAR - 30"	04-5530SN <b>\$122.50</b>	04-5530BLK <b>\$110.00</b>	04-5530 <b>\$110.00</b>	10
B. SINGLE ROBE HOOK	04-5501SN <b>\$ 48.81</b>	04-5501BLK <b>\$ 42.44</b>	04-5501 <b>\$ 42.44</b>	10
C. PAPER HOLDER	04-5548SN <b>\$ 72.99</b>	04-5548BLK <b>\$ 63.47</b>	04-5548 <b>\$ 63.47</b>	10
D. TOWEL RING	04-5504SN <b>\$ 74.95</b>	04-5504BLK <b>\$ 65.18</b>	04-5504 <b>\$ 65.18</b>	10

THE COLLECTIONS

Spellbound



VISUAL PACK		POLISHED CHROME 26	CASE QTY.
A. TOWEL BAR - 18"		02-D32118 <b>\$74.68</b>	4
TOWEL BAR - 24"		02-D32124 <b>\$87.34</b>	4
B. HAND TOWEL BAR		02-D32110 <b>\$66.39</b>	4
C. SINGLE ROBE HOOK		02-D32101 <b>\$36.27</b>	4
D. PAPER HOLDER		02-D32148 <b>\$56.76</b>	4
BOX PACK			
A. TOWEL BAR - 18"		04-32118 <b>\$74.68</b>	10
TOWEL BAR - 24"		04-32124 <b>\$87.34</b>	10
TOWEL BAR - 30"		04-32130 <b>\$95.43</b>	10
B. HAND TOWEL BAR		04-32110 <b>\$66.39</b>	10
C. SINGLE ROBE HOOK		04-32101 <b>\$36.27</b>	10
D. PAPER HOLDER		04-32148 <b>\$56.76</b>	10

Ultra



New!

New!

BATHSETS   VISUAL PACK	SATIN NICKEL 15	MATTE BLACK 19	POLISHED CHROME 26	CASE QTY.
4 PC. BATHSET   24" TOWEL BAR, SINGLE ROBE HOOK, PAPER HOLDER, TOWEL RING	02-B1752SN <b>\$204.30</b>	02-B1752BLK <b>\$176.91</b>	02-B1752 <b>\$176.91</b>	10

Orion

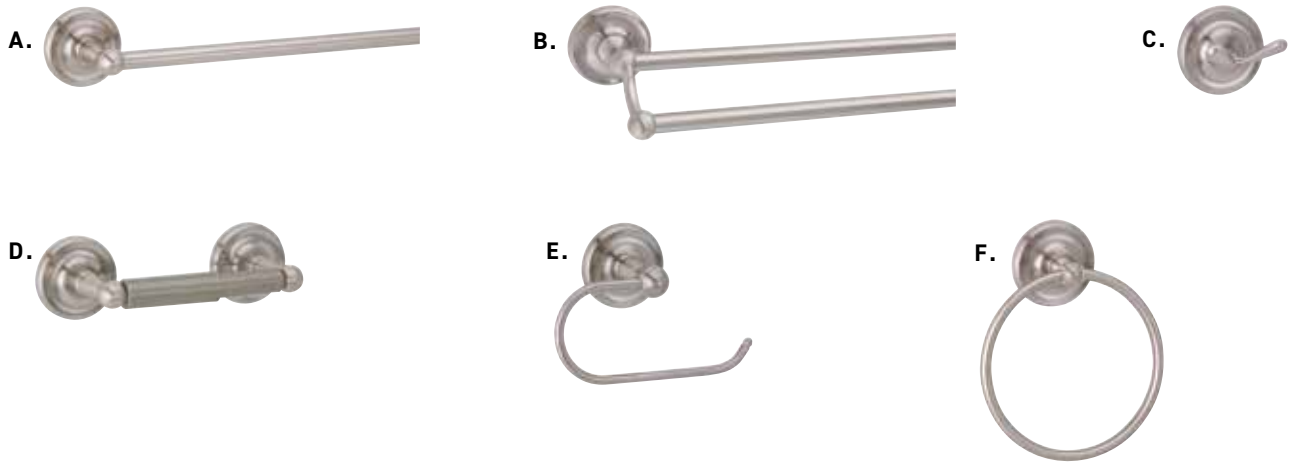

VISUAL PACK	SATIN NICKEL 15		POLISHED CHROME 26		CASE QTY.
A. TOWEL BAR - 18"	02-D6018SN	\$ 66.22	02-D6018	\$57.59	4
TOWEL BAR - 24"	02-D6024SN	\$ 73.60	02-D6024	\$63.98	4
B. DOUBLE TOWEL BAR - 24"	02-D6024DSN	\$118.21	02-D6024D	\$102.77	4
C. DOUBLE ROBE HOOK	02-D6002SN	\$ 29.31	02-D6002	\$25.49	4
D. PAPER HOLDER	02-D6008SN	\$ 65.13	02-D6008	\$56.63	4
E. PAPER HOLDER	02-D6048SN	\$ 65.13	02-D6048	\$56.63	4
F. TOWEL RING	02-D6004SN	\$ 50.05	02-D6004	\$43.53	4

Robson



BATH SET   VISUAL PACK	POLISHED CHROME 26		CASE QTY.
4 PC. BATH SET   24" TOWEL BAR, SINGLE ROBE HOOK, PAPER HOLDER, TOWEL RING	02-B30952	\$175.75	10



ARCTIC FOX BATH HARDWARE IN POLISHED CHROME

**Arctic Fox**

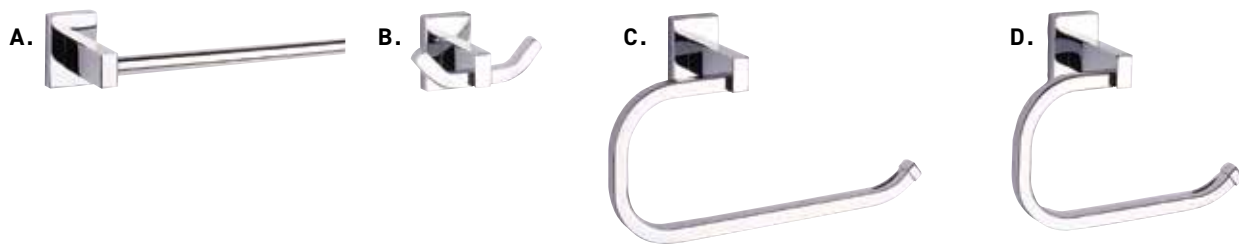

VISUAL PACK	SATIN NICKEL 15		POLISHED CHROME 26		CASE QTY.
A. TOWEL BAR - 18"	02-D33218SN	<b>\$76.85</b>	02-D33218	<b>\$66.83</b>	4
TOWEL BAR - 24"	02-D33224SN	<b>\$82.87</b>	02-D33224	<b>\$72.07</b>	4
B. DOUBLE ROBE HOOK	02-D33202SN	<b>\$41.61</b>	02-D33202	<b>\$36.19</b>	4
C. TOWEL RING	02-D33204SN	<b>\$53.58</b>	02-D33204	<b>\$46.60</b>	4
D. PAPER HOLDER	02-D33248SN	<b>\$54.96</b>	02-D33248	<b>\$47.80</b>	4





NORTHERN LIGHTS BATH HARDWARE IN POLISHED CHROME

## Northern Lights



VISUAL PACK	POLISHED CHROME 26	CASE QTY.
A. TOWEL BAR - 18"	02-D33118 <b>\$55.15</b>	4
TOWEL BAR - 24"	02-D33124 <b>\$58.27</b>	4
B. SINGLE ROBE HOOK	02-D33101 <b>\$28.16</b>	4
C. PAPER HOLDER	02-D33148 <b>\$38.48</b>	4
D. TOWEL RING	02-D33104 <b>\$38.45</b>	4

## Yates



VISUAL PACK	POLISHED CHROME 26		CASE QTY.
A. TOWEL BAR - 18"	02-D20418	<b>\$47.73</b>	4
TOWEL BAR - 24"	02-D20424	<b>\$53.04</b>	4
B. DOUBLE ROBE HOOK	02-D20402	<b>\$21.26</b>	4
C. PAPER HOLDER	02-D20408	<b>\$45.79</b>	4
D. PAPER HOLDER	02-D20448	<b>\$33.26</b>	4
E. TOWEL RING	02-D20404	<b>\$34.37</b>	4
BATHSETS   VISUAL PACK			
4 PC. BATHSET   24" TOWEL BAR, DOUBLE ROBE HOOK, PAPER HOLDER (D), TOWEL RING	02-B20450	<b>\$128.05</b>	10

## Infinity

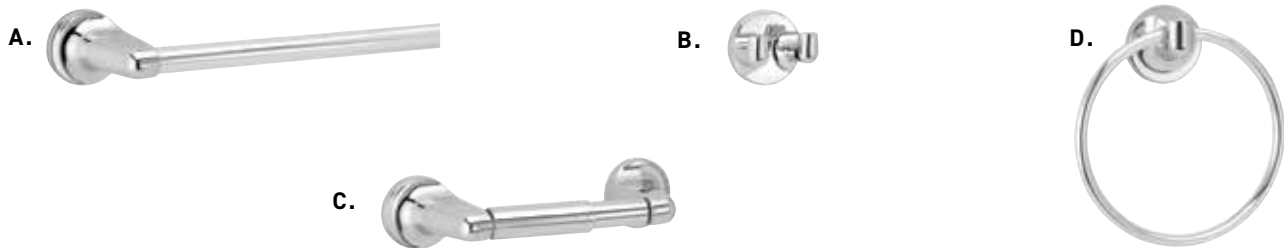

VISUAL PACK	SATIN NICKEL 15		POLISHED CHROME 26		CASE QTY.
A. TOWEL BAR - 18"	02-D8418SN	<b>\$51.59</b>	02-D8418	<b>\$44.87</b>	4
TOWEL BAR - 24"	02-D8424SN	<b>\$57.32</b>	02-D8424	<b>\$49.85</b>	4
TOWEL BAR - 30"	02-D8430SN	<b>\$65.91</b>	02-D8430	<b>\$57.32</b>	4
B. DOUBLE ROBE HOOK	02-D8402SN	<b>\$17.06</b>	02-D8402	<b>\$14.83</b>	4
C. PAPER HOLDER	02-D8408SN	<b>\$44.06</b>	02-D8408	<b>\$38.31</b>	4
D. TOWEL RING	02-D8404SN	<b>\$30.62</b>	02-D8404	<b>\$26.64</b>	4
BOX PACK					
A. TOWEL BAR - 18"	04-SN8418	<b>\$51.59</b>	04-8418	<b>\$44.87</b>	10
TOWEL BAR - 24"	04-SN8424	<b>\$57.32</b>	04-8424	<b>\$49.85</b>	10
B. DOUBLE ROBE HOOK	04-SN8402	<b>\$17.06</b>	04-8402	<b>\$14.83</b>	10
C. PAPER HOLDER	04-SN8408	<b>\$44.06</b>	04-8408	<b>\$38.31</b>	10
D. TOWEL RING	04-SN8404	<b>\$30.62</b>	04-8404	<b>\$26.64</b>	10
BATHSETS   VISUAL PACK					
4 PC. BATHSET   24" TOWEL BAR, SINGLE ROBE HOOK*, PAPER HOLDER, TOWEL RING	02-B8450SN	<b>\$133.87</b>	02-B8450	<b>\$116.43</b>	10

\*SINGLE ROBE HOOK NOT SHOWN

Columbia

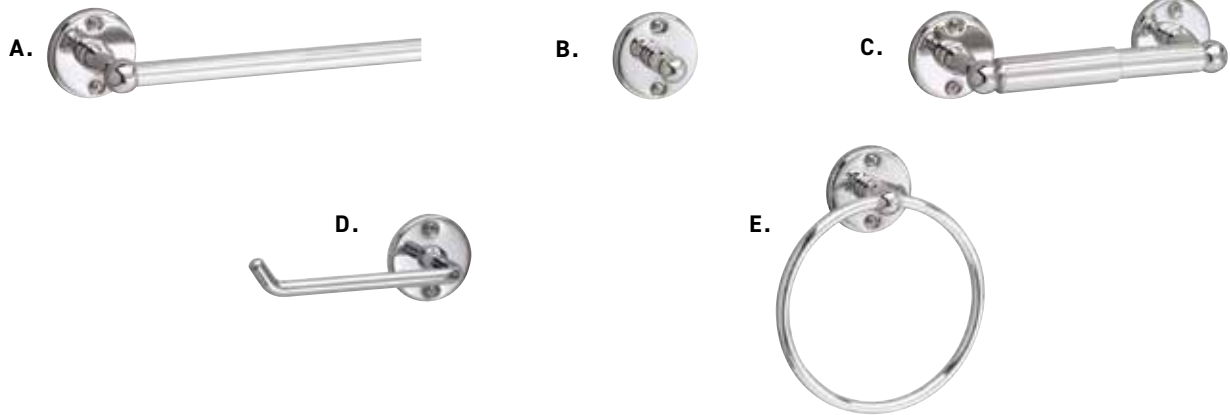

VISUAL PACK	SATIN NICKEL 15		POLISHED CHROME 26		CASE QTY.
A. TOWEL BAR - 18"	02-D5018SN	\$42.76	02-D5018	\$37.17	4
TOWEL BAR - 24"	02-D5024SN	\$47.50	02-D5024	\$41.32	4
B. SINGLE ROBE HOOK	02-D5001SN	\$16.79	02-D5001	\$14.62	4
C. PAPER HOLDER	02-D5008SN	\$37.32	02-D5008	\$32.45	4
D. PAPER HOLDER	02-D5048SN	\$36.02	02-D5048	\$31.34	4
E. TOWEL RING	02-D5004SN	\$27.30	02-D5004	\$23.73	4

Fundamentals

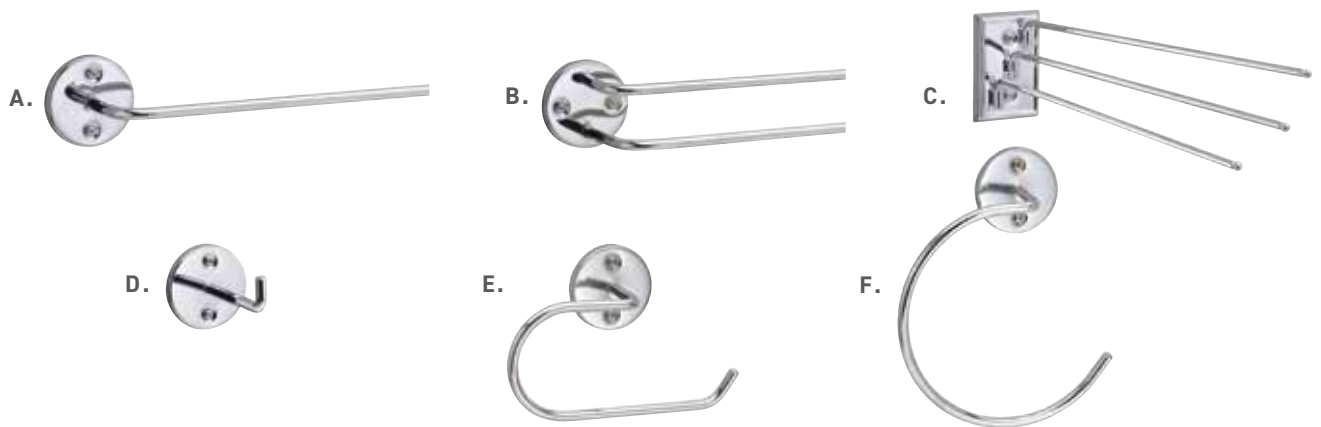

VISUAL PACK	SATIN NICKEL 15		POLISHED CHROME 26		CASE QTY.
A. TOWEL BAR - 9"	02-D1109	\$ 9.89	02-D1109	\$ 9.89	4
TOWEL BAR - 12"	02-D1112	\$13.22	02-D1112	\$13.22	4
TOWEL BAR - 15"	02-D1115	\$16.01	02-D1115	\$16.01	4
TOWEL BAR - 18"	02-D1118	\$17.78	02-D1118	\$17.78	4
TOWEL BAR - 24"	02-D1124	\$19.74	02-D1124	\$19.74	4
B. DOUBLE TOWEL BAR - 24"	02-D1124D	\$29.81	02-D1124D	\$29.81	4
C. TOWEL HOLDER - 3 ARM	02-D1111	\$24.15	02-D1111	\$24.15	4
D. SINGLE ROBE HOOK	02-D1101	\$ 6.56	02-D1101	\$ 6.56	4
E. PAPER HOLDER	02-D1148	\$13.22	02-D1148	\$13.22	4
F. TOWEL RING	02-D1104	\$13.22	02-D1104	\$13.22	4

THE COLLECTIONS

Sunglow



VISUAL PACK	POLISHED CHROME 26		CASE QTY.
A. TOWEL BAR - 18"	02-D940018	<b>\$34.73</b>	4
TOWEL BAR - 24"	02-D940024	<b>\$37.81</b>	4
TOWEL BAR - 30"	02-D940030	<b>\$43.49</b>	4
B. DOUBLE ROBE HOOK	02-D9402	<b>\$ 9.88</b>	4
C. PAPER HOLDER WITH WHITE PLASTIC ROLLER	02-D9408	<b>\$23.78</b>	4
D. RECESSED PAPER HOLDER - SCREW-IN	02-D101S	<b>\$51.58</b>	5
E. TOWEL RING	02-D9404	<b>\$23.78</b>	4

BOX PACK POLISHED CHROME 26 | CASE QTY. 50

STAINLESS STEEL TOWEL BARS			REPLACEMENT PARTS 3/4"		
A. TOWEL BAR - 18"	01-940018	<b>\$32.98</b>	18" BAR ONLY	01-R940018	<b>\$10.02</b>
TOWEL BAR - 24"	01-940024	<b>\$37.25</b>	24" BAR ONLY	01-R940024	<b>\$14.35</b>
TOWEL BAR - 30"	01-940030	<b>\$42.19</b>	30" BAR ONLY	01-R940030	<b>\$19.24</b>
			POSTS ONLY (PAIR)	01-R9400P	<b>\$22.94</b>
B. DOUBLE ROBE HOOK			01-9402	<b>\$ 9.60</b>	50
C. PAPER HOLDER WITH WHITE PLASTIC ROLLER			01-9408	<b>\$22.00</b>	50
E. TOWEL RING			01-9404	<b>\$22.42</b>	50
F. INSTALLATION CLAMP			01-1003	<b>\$12.54</b>	10

BATH HARDWARE

# Bathsets | Quick Find

**Robson** | pg. 143



POLISHED CHROME                      02-B30952                      **\$175.75**

**Ultra** | pg. 142



SATIN NICKEL **New!**                      02-B1752SN  
 MATTE BLACK **New!**                      02-B1752BLK  
 POLISHED CHROME                      02-B1752

**\$204.30**  
**\$176.91**  
**\$176.91**

**Yates** | pg. 146



POLISHED CHROME                      02-B20450                      **\$128.05**

**Infinity** | pg. 146



POLISHED CHROME                      02-B8450  
 SATIN NICKEL                      02-B8450SN

**\$116.43**  
**\$133.87**

BATH HARDWARE



ADJUSTABLE CURVED SHOWER ROD IN POLISHED CHROME AND METAL SHOWER CURTAIN HOOKS WITH ROLLER BALLS

## Bath Accents

Transform your bathroom into an efficient, uncluttered space with our versatile bath accents for both residential and commercial applications. From towel shelves to shower baskets, our highly functional bath accents provide space for everything you need along with smart ways to organize it.

Hotel Style Towel Shelves

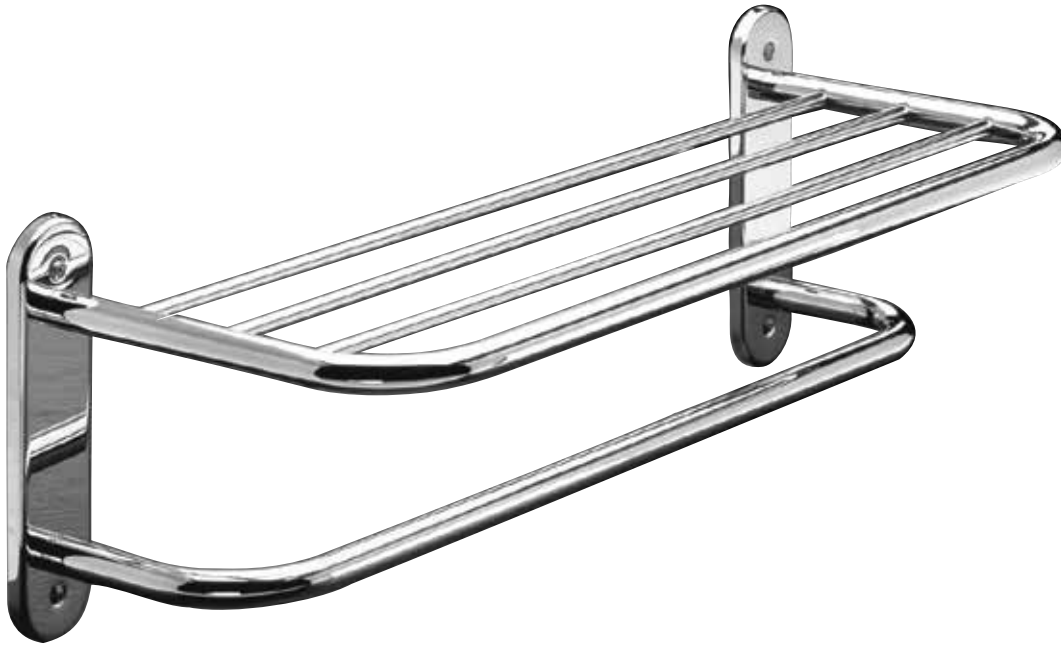

**Towel Shelf with Bar**

24" Overall dimensions: 26-1/8" x 8-1/2" x 9" (66.4 cm x 21.6 cm x 22.9 cm)

- › Semi-concealed surface mount application
- › Includes 4 plastic anchors and 4 steel Phillips head screws – #8 x 2" (50.8 mm)
- › 3/4" (19.05 mm) tubing

BOX PACK	POLISHED CHROME 26		CASE QTY.
24" TOWEL SHELF WITH BAR	01-1044	<b>\$166.19</b>	5

Shower Baskets

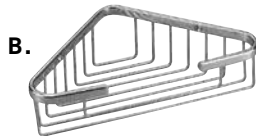

- › Exposed surface mount application
- › Includes 4 – #8 x 1-1/4" (31.75 mm) steel Phillips head screws

**A. Small Corner Basket**

› 8-1/4"L x 5"W x 1-5/8"D  
(210 mm L x 127 mm W x 41 mm D)

**B. Medium Corner Basket**

› 9"L x 5-3/8"W x 2-1/2"D  
(229 mm L x 136 mm W x 64 mm D)

**C. Rectangle Basket**

› 6-1/4"L x 4-1/4"D x 1-5/8"H  
(159 mm L x 108 mm W x 41 mm D)

VISUAL PACK	POLISHED CHROME 26		CASE QTY.
A. SMALL CORNER BASKET	05-1086S	<b>\$ 76.50</b>	6
B. MEDIUM CORNER BASKET	05-1086M	<b>\$100.38</b>	6
C. RECTANGLE BASKET	05-1083S	<b>\$ 73.42</b>	6

## SHOWER CURTAIN HOOKS & SHOWER RODS

### Metal Curtain Hooks

› 12 hooks per pack



BOX PACK	POLISHED CHROME 26	CASE QTY.
METAL SHOWER CURTAIN HOOKS	01-R9689H <b>\$10.21</b>	20



STAINLESS STEEL SHOWER ROD WITH POWDER COATED FLANGES, MATTE BLACK - SEE PAGE 153, FLANGES "D."

### Shower Rods

#### Extendable Tension Shower Rods

› Fits 5' & 6' bathtub stalls › Extends from 40" to 72" (102 cm to 183 cm)



VISUAL PACK	POLISHED CHROME 26	CASE QTY.
EXTENDABLE TENSION SHOWER RODS	02-DP9682 <b>\$37.61</b>	12

#### Adjustable Length Tension Shower Rod

› Powerful spring tension for easy installation without tools or drilling  
 › Plastic double-tapered center ring to prevent shower curtain rings from getting caught  
 › Rubber caps on both ends to prevent slipping  
 › Steel construction  
 › Extends from 36" to 62" (92 cm to 157.48 cm)



VISUAL PACK	POLISHED CHROME 26	WHITE	CASE QTY.
ADJUSTABLE LENGTH TENSION SHOWER ROD	02-DP9680 <b>\$37.21</b>	02-DP9680W <b>\$37.21</b>	12

#### Aluminum Shower Rod

› One-piece shower rod only › 1" (25 mm) outer diameter  
 › 0.025" (0.635 mm) wall thickness › Aluminum does not rust



BOX PACK		ALUMINUM 28	CASE QTY.
5' (1.525 m) ALUMINUM SHOWER ROD ONLY	-	01-R9689 <b>\$20.32</b>	50
6' (1.83 m) ALUMINUM SHOWER ROD ONLY	-	01-R9686 <b>\$29.40</b>	50



#### A. 304 Stainless Steel Shower Rod

› One-piece shower rod only › 1" (25 mm) outer diameter  
 › 0.025" (0.635 mm) wall thickness › Chrome plated  
 › Rust preventative treatment added



#### B. Shower Rod Cover

› Wraps around existing standard 1" (25 mm) O.D. shower rods  
 › Can be used to cover rusty shower rods or improve glide of shower curtain rings  
 › 59-5/8" (151.4 cm) long

BOX PACK	<b>New!</b> MATTE BLACK 19	<b>New!</b> SATIN STAINLESS STEEL 32D	POLISHED STAINLESS STEEL 32	CASE QTY.
A. 5' (1.5 m) 304 STAINLESS STEEL SHOWER ROD ONLY	01-9525BLK <b>\$40.23</b>	01-9525SSS <b>\$40.23</b>	01-9525PSS <b>\$36.58</b>	12
A. 6' (1.8 m) 304 STAINLESS STEEL SHOWER ROD ONLY	-	-	01-9625PSS <b>\$43.46</b>	12
B. SHOWER ROD COVER			WHITE SHOWER ROD COVER 01-9629W <b>\$5.18</b>	20

#### Adjustable Curved Shower Rod

› Fits showers 52" to 72" (132 cm to 183 cm)  
 › Flanges included › Plated steel

VISUAL PACK	POLISHED CHROME 26	CASE QTY.
ADJUSTABLE CURVED SHOWER ROD	02-D9688 <b>\$69.14</b>	4

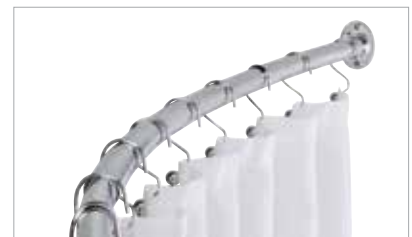





CURVED SHOWER ROD WITH SWIVEL FLANGES  
POLISHED CHROME

**Curved Shower Rod with Swivel Flanges**

- › All curved shower rods protrudes 9-1/2" (241 mm) at center
- › Flanges included › Stainless steel

BOX PACK		<b>New!</b> SATIN NICKEL 15	<b>New!</b> MATTE BLACK 19	POLISHED STAINLESS STEEL 32	CASE QTY.
5' (1.5 m) SHOWER ROD - .025" WALL THICKNESS (23 GAUGE), CLEAN CUT ROD	01-C9189SN	\$104.95	01-C9189BLK	\$104.95	01-C9189 \$95.39 6



**Curved Shower Rod** **New!**

- › Stainless steel construction › Powder coated finish
- › 1" (25 mm) outside diameter › Round flanges included
- › Protrudes 6" (153 mm) at center › Concealed mounting screws

BOX PACK		SATIN NICKEL 15	MATTE BLACK 19	POLISHED CHROME 26	CASE QTY.
5' (1.5 m) LONG - .020" WALL THICKNESS (25 GAUGE), CLEAN CUT ROD	01-C6289SN	\$125.92	01-C6289BLK	\$125.92	01-C6289 \$114.48 6



**A. Aluminum Shower Rod Kit "A"**

- Comes with: › 5' (1.525 m) one-piece aluminum shower rod › One pair of elliptical shaped ABS plastic flanges with exposed screw mount › Pack of 12 shower curtain hooks



**B. Aluminum Shower Rod Kit "B"**

- Comes with: › One-piece aluminum shower rod › One pair of circle shaped steel flanges with concealed screw mount



**C. Aluminum Shower Rod Kit "C"**

- Comes with: › One-piece aluminum shower rod › One pair of adjustable tension flanges

VISUAL PACK		ALUMINUM 28	CASE QTY.
A. 5' (1.525 m) ALUMINUM SHOWER ROD KIT	02-D9689	\$38.02	10
B. 5' (1.525 m) ALUMINUM SHOWER ROD KIT	02-DP9683	\$51.61	10
C. 5' (1.525 m) ALUMINUM SHOWER ROD KIT	02-D9789	\$36.38	10

**Flanges**



**Adjustable Tension Shower Rod Flanges**

- › Allows use of one-piece shower rod without drilling holes or adhesives
- › Can add up to 3/4" (19 mm) of tension to the shower rod
- › Rubber ends on both sides prevent slipping

**Notes**

Fits standard 1" (25 mm) outer diameter shower rods

BOX PACK	MATERIAL	<b>New!</b> SATIN NICKEL 15	<b>New!</b> MATTE BLACK 19	POLISHED CHROME 26	CASE QTY.
A. ADJUSTABLE TENSION SHOWER ROD FLANGE	ZINC & ALUMINUM METAL ALLOY CASTING	01-9656SN \$13.41	01-9656BLK \$13.41	01-9656 \$12.18	100 PRS
B. ROUND CONCEALED MOUNT SHOWER ROD FLANGE	ZINC & ALUMINUM METAL ALLOY CASTING	-	-	01-9659 \$ 8.35	50 PRS
C. SHOWER ROD FLANGE - ELLIPTICAL SHAPE	ABS CONSTRUCTION	-	-	01-R9689B \$ 5.78	25 PRS
D. ROUND SHOWER ROD FLANGE <b>New!</b>	ZINC	01-9663SN \$10.66	01-9663BLK \$10.66	01-9663 \$ 9.27	100 PRS



ASTRAL GRAB BAR IN POLISHED CHROME

## Bath Safety

Make your bathroom safer without compromising bath décor. With designs that meet ADA requirements, Taymor bath safety products improve bathroom accessibility in style.

### Astral



MEETS  
ADA STANDARDS 

ERGONOMIC NON-SLIP FINGER GRIP, CONCEALED MOUNT	POLISHED STAINLESS STEEL 32	CASE QTY.
16" (406 mm) - 1-1/4" (32 mm) O.D. - VISUAL PACK	03-6916PSS <b>\$128.61</b>	3
24" (610 mm) - 1-1/4" (32 mm) O.D. - VISUAL PACK	03-6924PSS <b>\$152.88</b>	3

**Concealed Mount Grab Bars**



**A. CONCEALED MOUNT | PEENED**



**B. 120° ANGLED CONCEALED MOUNT | PEENED**



**C. 90° ANGLED CONCEALED MOUNT | PEENED**

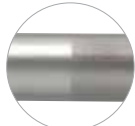

NON-SLIP PEENED GRIP

MEETS ADA STANDARDS 	VISUAL PACK CONCEALED MOUNT   PEENED SATIN STAINLESS STEEL 32D			BOX PACK CONCEALED MOUNT   PEENED SATIN STAINLESS STEEL 32D		
			CASE QTY.			CASE QTY.
A. 12" GRAB BAR (304 mm) - 1-1/4" (32 mm) O.D.	03-TC220012	\$ 77.07	3	01-TC220012	\$ 73.07	5
16" GRAB BAR (406 mm) - 1-1/4" (32 mm) O.D.	03-TC220016	\$ 83.40	3	-		
18" GRAB BAR (457 mm) - 1-1/4" (32 mm) O.D.	-			01-TC220018	\$ 85.65	5
24" GRAB BAR (610 mm) - 1-1/4" (32 mm) O.D.	03-TC220024	\$100.74	3	01-TC220024	\$ 95.61	5
30" GRAB BAR (762 mm) - 1-1/4" (32 mm) O.D.	-			01-TC220030	\$104.33	5
36" GRAB BAR (914 mm) - 1-1/4" (32 mm) O.D.	-			01-TC220036	\$115.93	5
48" GRAB BAR (1219 mm) - 1-1/4" (32 mm) O.D.	-			01-TC220048	\$136.08	5
B. 120° ANGLED GRAB BAR 24" x 24" (610 mm x 610 mm)	-			01-TC22120	\$251.74	5
C. 90° ANGLED GRAB BAR 30" x 30" (762 mm x 762 mm)	-			01-TC323030	\$213.87	10

**Exposed Mount Grab Bars**

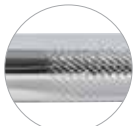

NON-SLIP KNURLED GRIP



135° ANGLED EXPOSED MOUNT | KNURLED



EXPOSED MOUNT | KNURLED



EXPOSED MOUNT | SMOOTH

VISUAL PACK	EXPOSED MOUNT   KNURLED POLISHED STAINLESS STEEL 32		EXPOSED MOUNT   SMOOTH WHITE FINISH STAINLESS STEEL		CASE QTY.
12" x 12" (304 mm x 304 mm) 135° ANGLED 1" O.D.	03-4905	\$107.09	-		10
12" (304 mm) - 1" (25 mm) O.D.	03-4912	\$ 52.43	03-5912	\$41.06	10
16" (406 mm) - 1" (25 mm) O.D.	03-4916	\$ 55.12	03-5916	\$46.19	10
18" (457 mm) - 1" (25 mm) O.D.	03-4918	\$ 59.07	03-5918	\$48.48	10
24" (610 mm) - 1" (25 mm) O.D.	03-4924	\$ 68.36	03-5924	\$51.18	10
32" (812 mm) - 1" (25 mm) O.D.	03-4932	\$ 83.94	-		10

\*Exposed Mount Grab Bars are not rated for commercial use

# Warranty Information

## DOOR HARDWARE, RESIDENTIAL & COMMERCIAL LOCKS/HARDWARE WARRANTY

Taymor is pleased to offer a Lifetime Mechanical and Finish Warranty against defects in materials and workmanship for one full year to the original purchaser, effective from the date of purchase, unless otherwise specified. Taymor provides a Lifetime Finish Warranty against corrosion, tarnishing, discolouration, and environmental impacts on its products; however, this does not apply to scratches, abrasions, normal wear and tear, accidental damage, corrosive or abrasive cleaning agents or misused products. This warranty is non-transferable and applies to products installed in a residential setting. Commercial use is only covered for our Commercial products as outlined in the chart below. Taymor is not liable for damages caused by incorrect installation nor incidental or consequential damages. At the company's discretion, Taymor will replace any part or finish that proves to be defective in material and/or workmanship under normal installation, use and service.

	THE PREMIER LINE	PROFESSIONAL SERIES®	BUILDERS SERIES	EPIC LOCK SERIES®	COMMERCIAL GRADE 1 Locksets, Door Closers & Exit Hardware	COMMERCIAL OTHER Locksets, Door Closers & Exit Hardware
<b>Mechanical</b>	Lifetime*	Lifetime*	Lifetime*	Lifetime*	10 year	5 year
<b>Finish</b>	Lifetime*	5 year	5 year	1 year	1 year	1 year
<b>Digital**</b>	-	1 year	-	-	-	-

\* Lifetime  
 \*\*Applies to Taymor Professional Series® Centinel and Concierge digital deadbolts only.

## BATH HARDWARE & FAUCETS WARRANTY

Taymor is pleased to offer a Lifetime Warranty against defects in materials and workmanship, to the original consumer purchaser from the date of purchase, as long as the original consumer purchaser owns the home in which the product(s) are installed.

This warranty excludes products that have been damaged through misuse, accidental damage, alteration, normal wear and tear, or by the use of corrosive or abrasive cleaning agents. This warranty applies to products installed in a residential setting. Purchasers for industrial, commercial and business usage are covered by a 5 year limited warranty from the date of purchase.

Taymor is not liable for damages caused by incorrect installation nor incidental or consequential damages. At the company's discretion, Taymor will replace any part or finish that proves to be defective in material and/or workmanship under normal installation, use and service. This warranty does not cover shipping costs, labor costs or any other cost associated with the installation or replacement of the product/parts and is extended only to the original consumer purchaser of the product(s). The original sales receipt must be supplied to Taymor for all warranty claims.

Taymor recommends using a certified plumber for installation and repair of faucets.

**\*\*Taymor Fundamentals faucets are backed by a 1 Year Limited Warranty from date of purchase**

## CARE & CLEANING TIPS

Taymor uses advanced technology to create a finish highly resistant to the effects of weather and normal wear and tear. Over time, frequency of use will cause some finishes to gracefully age in appearance. Additionally, exposure to atmospheric conditions and elements such as cleaning chemicals may cause some changes to occur. These finish changes are not considered manufacturing defects and are not covered by warranty. Rather, they are indicative of normal wear and tear. As always, following the manufacturer's care instructions will safeguard the longevity of your cherished Taymor product.

**DO:** Clean the product with mild soap and warm water. For best results, dry immediately with a soft, clean cloth.

**DON'T:** Do not use abrasive sponges or scouring agents for cleaning. We also advise against the use of solvents or acidic cleaners, lime scale removers, household vinegar and cleaning agents containing acetic acid.

**For additional information** or questions regarding Taymor warranties, please contact our Customer Service team:

**WEST** | 800 267 4774 | custserv@taymor.com

**EAST** | 800 387 7064 | customerservicetor@taymor.com

# Terms & Conditions

## TERMS

All terms and conditions are subject to change without notice. Invoices are due Net 30 days from date of invoice. Past due accounts are subject to a service charge of 2% per month.

## FREIGHT

Taymor Warehouse orders are prepaid as per the following grid.

### PREPAID FREIGHT ON ORDERS

\$750 or more	for British Columbia, Alberta, Saskatchewan, Manitoba, Ontario, Quebec, New Brunswick, Nova Scotia & Prince Edward Island
\$750 or more	for Northern Ontario, Northern Quebec & Newfoundland/Labrador

All orders to the Northwest Territories, Yukon & Nunavut are FOB Taymor unless otherwise specified

Warehouse orders not meeting the minimums specified above are FOB Taymor warehouse. Unless the method of transportation is specified at the time of order, we will use the most cost effective carrier available. Container Direct orders are not covered by the above. All freight specifics for Container Direct will be detailed at the time of order.

## BACK ORDERS

Back orders will be shipped prepaid. If back orders are not desired, please specify on your original order.

## SHORTAGES & OTHER IRREGULARITIES

Unless Taymor is notified within 5 days of receipt of shipment of any shortages or irregularities regarding quantities shipped, terms or conditions of sale, it will be assumed that the customer has accepted the order as shipped and invoiced. **Customer must initiate and file a claim with the carrier for missing or damaged goods, as the carrier is responsible once they sign the bill of lading. Please note any discrepancies on the carrier's delivery slip before accepting shipment and request an inspection by the carrier.**

## RETURNED GOODS POLICY

- › Taymor considers all sales final.
- › All returns require prior authorization. Please include R.G.A. # (Returned Goods Agreement #) in each box returned complete with: item #, description, quantity, condition of goods and freight responsibility.
- › All documentation including packing slips, waybills and claims must prominently state the R.G.A. #.
- › All unauthorized returns are subject to a 30% restocking charge, if accepted by Taymor.
- › Please contact your sales representative for further information.
- › All returned goods must be in saleable condition. Products/Goods returned in shop worn or severely damaged condition and/or missing parts will not be accepted. Please contact your Taymor Sales Associate for inspection and resolution prior to returning.
- › Products that have been purchased over 12 months prior to a return are subject to review by the Taymor Sales Associate prior to shipping to Taymor warehouses.
- › Discontinued and special order items cannot be returned.
- › Return transportation must be prepaid by the customer.
- › All credits will be issued at the invoiced price at the time of original purchase.

## PRICES

All prices are subject to change without notice. Errors and omissions are subject to corrections. Merchandise will be shipped at prices in effect at time of receipt of order. All prices are exclusive of GST/HST/QST and other taxes that may apply.

# Door Hardware Index

## DEADBOLTS

Builder Series	
Single Cylinder Deadbolt _____	<b>78</b>
Commercial	
Grade 1 Single Cylinder - Maximum Duty _____	<b>100</b>
Occupancy Indicator Deadbolt _____	<b>102</b>
Single Cylinder Deadbolt - Heavy Duty _____	<b>102</b>
Single Cylinder Deadbolt - Light Duty _____	<b>103</b>
Single Sided Communicating Deadbolt _____	<b>102</b>
Epic Lock Series®	
Single Cylinder Deadbolt _____	<b>79</b>
Professional Select®	
Single Cylinder Deadbolts _____	<b>67</b>
Professional Series®	
Digital Deadbolts _____	<b>72-74</b>
Single Cylinder Deadbolts _____	<b>75</b>
Combo Pack Single Cylinder Deadbolt & Villa Ball Knob _____	<b>75</b>
The Premier Line	
Premier Flush Deadbolts - Builder _____	<b>57</b>
Premier Standard Deadbolts - Retail _____	<b>57</b>

## DOOR CLOSERS

Grade 1 - 4000 Series _____	<b>105</b>
Grade 1 - 1900 Series _____	<b>106</b>
Grade 2 - 550 Series _____	<b>107</b>
Grade 3 - 600 Series _____	<b>107</b>
Grade 3 - 690 Series _____	<b>107</b>

## ESCUTCHEON PLATES \_\_\_\_\_ **114**

## EXTERIOR HARDWARE

Address Plaques _____	<b>86</b>
Door Knockers _____	<b>87</b>
Door Viewers _____	<b>88</b>
House Numbers _____	<b>84</b>
Kick Plates _____	<b>89</b>

## EXIT HARDWARE

900 Series Push Bar Exit Device _____	<b>111</b>
900 Series Escutcheon Lever Trim Accessories _____	<b>111</b>
8500 Series Push Pad Exit Device _____	<b>108</b>
8500/9700 Series Escutcheon Lever Trim _____	<b>110</b>
8500/9700 Series Knob & Lever Trim _____	<b>109</b>
8500/9700 Series Outside Thumbpiece Trims _____	<b>110</b>
9700 Series Push Pad Exit Device _____	<b>109</b>

## FINISH GUIDES \_\_\_\_\_ **121**

## FIRE RATING \_\_\_\_\_ **121**

## HANDLESETS

Epic Lock Series®	
Handleset _____	<b>79</b>
The Premier Line	
London _____	<b>63</b>
Professional Select®	
Leading Edge _____	<b>67</b>
Professional Series®	
Ashford _____	<b>77</b>
Madera _____	<b>77</b>
Strait _____	<b>77</b>

## HANDLESET CUSTOMIZATION \_\_\_\_\_ **120**

## INTERCONNECTED LOCKS

Taymor Premier Interconnected Locks _____	<b>60-62</b>
---	--------------

## INTERIOR HARDWARE

Bolts - Surface & Flush _____	<b>96</b>
Cam Locks _____	<b>97</b>
Chain Check - Heavy Duty _____	<b>97</b>
Closet & Cabinet Hardware	
Adjustable Steel Closet Rods _____	<b>94</b>
Catches _____	<b>95</b>
Door Pulls _____	<b>94</b>
Knobs _____	<b>93</b>
Shelf & Rod Supports _____	<b>94</b>
Door Guards _____	<b>96</b>
Door, Floor, Wall Stops _____	<b>92</b>
Handrail Brackets _____	<b>95</b>
Hinges _____	<b>90-91</b>
Pull & Push Plates _____	<b>97</b>

## KEYING & ACCESSORIES \_\_\_\_\_ **112-117**

**KNOBSETS**

Builder Series	
Basic Ball _____	<b>78</b>
Commercial	
Oxford - Light Duty _____	<b>103</b>
York - Heavy Duty _____	<b>102</b>
Epic Lock Series®	
Full Ball Knob _____	<b>79</b>
Professional Series®	
Manchester Dome _____	<b>71</b>
Villa Ball _____	<b>71</b>
The Premier Line	
The Premier Line	
Barcelona _____	<b>55</b>

**LEVERSETS**

Builder Series	
Orleans _____	<b>78</b>
Perspective _____	<b>78</b>
Silver Moon _____	<b>78</b>
Commercial	
Citadel - Heavy Duty _____	<b>101</b>
Duke - Heavy Duty _____	<b>101</b>
Excalibur - Heavy Duty _____	<b>102</b>
Knight - Maximum Duty _____	<b>100</b>
Windsor - Light Duty _____	<b>103</b>
Epic Lock Series®	
Arc _____	<b>79</b>
Axia _____	<b>79</b>
Straight _____	<b>79</b>
Professional Select®	
Cross Flow _____	<b>67</b>
Free Style _____	<b>66</b>
Pace Line _____	<b>66</b>
Ramp Up _____	<b>66</b>
Professional Series®	
Bristol _____	<b>70</b>
Hampton _____	<b>70</b>
Provence _____	<b>70</b>
The Premier Line	
1948 Lever _____	<b>53</b>
Arc Deco _____	<b>51</b>
Bergen _____	<b>55</b>
Britannia _____	<b>55</b>
Equinox _____	<b>54</b>
Full Bloom _____	<b>50</b>
Slip Stream _____	<b>52</b>
Stockholm _____	<b>55</b>
Vega _____	<b>54</b>

**MORTISE LOCKS**

Commercial	
Accessories _____	<b>104</b>
Cylinders _____	<b>104</b>
Duke Mortise _____	<b>104</b>
The Premier Line	
Arc Deco Mortise _____	<b>59</b>
Bergen Mortise _____	<b>59</b>
Britannia Mortise _____	<b>59</b>
Cylinders _____	<b>59</b>
Slip Stream Mortise _____	<b>59</b>
Stockholm Mortise _____	<b>59</b>
Vega Mortise _____	<b>59</b>

**PARTS**

Residential	
Escutcheon Plates _____	<b>114</b>
Keying & Accessories _____	<b>115</b>
Latches _____	<b>117</b>
Strikes _____	<b>116</b>
Commercial	
Extension Link _____	<b>118</b>
Keying & Accessories _____	<b>115</b>
Keying Kit _____	<b>115</b>
Latches _____	<b>117</b>

**PRO/KEY PROGRAM \_\_\_\_\_ 80 & 112****ROSE KITS**

The Premier Line	
Square Contemporary Rose Kit _____	<b>56</b>

**SLIDING DOOR LOCKS**

Rectangular Sliding Door Locks _____	<b>71</b>
Round Sliding Door Locks _____	<b>71</b>

# Bath Hardware Index

## BATHSETS

4 Piece Bathsets	
Infinity _____	146
Robson _____	143
Ultra _____	142
Yates _____	146
Bathsets Quick Find _____	149

## CADDIES & BASKETS

- SHOWER & BATHTUB _____	151
--------------------------	-----

## GRAB BARS

Astral _____	154
Concealed Mount _____	155
Exposed Mount _____	155

INSTALLATION CLAMP _____	148
--------------------------	-----

## PAPER HOLDERS

1948 Round _____	132
1948 Square _____	133
Allusion _____	137
Arc Deco _____	128-129
Arctic Fox _____	144
Astral _____	138
Bitter Suite _____	135
Columbia _____	147
Dual Harmony _____	126-127
Electra _____	136
Fundamentals _____	147
Infinity _____	146
Lund _____	140
Naples _____	141
Northern Lights _____	145
Orion _____	143
Qube _____	140
Slip Stream _____	130-131
Spellbound _____	142
Sunglow _____	148
Suite and Simple® _____	134
Wave _____	139
Yates _____	146

## PAPER HOLDERS - PIVOTING

Arc Deco _____	128-129
Astral _____	138

PAPER HOLDERS - RECESSED _____	148
--------------------------------	-----

## PAPER HOLDERS - VERTICAL

Electra _____	136
Lund _____	140

## ROBE HOOKS

### Double

1948 Round _____	132
1948 Square _____	133
Arc Deco _____	128-129
Arctic Fox _____	144
Infinity _____	146
Lund _____	140
Orion _____	143
Slip Stream _____	130-131
Sunglow _____	148
Suite and Simple® _____	134
Wave _____	139
Yates _____	146

### Single

Allusion _____	137
Arc Deco _____	128-129
Astral _____	138
Bitter Suite _____	135
Columbia _____	147
Electra _____	136
Fundamentals _____	147
Naples _____	141
Northern Lights _____	145
Qube _____	140
Spellbound _____	142

SHOWER CURTAINS HOOKS _____	152
-----------------------------	-----

SHOWER BASKETS _____	151
----------------------	-----

SHOWER RODS _____	152-153
-------------------	---------

SHOWER ROD COVERS _____	152
-------------------------	-----

SHOWER ROD FLANGES _____	153
--------------------------	-----



**TOWEL BARS**

Hand Towel Bars	
1948 Round _____	<b>132</b>
Allusion _____	<b>137</b>
Arc Deco _____	<b>128-129</b>
Astral _____	<b>138</b>
Dual Harmony _____	<b>126-127</b>
Fundamentals _____	<b>147</b>
Slip Stream _____	<b>130-131</b>
Spellbound _____	<b>142</b>
Wave _____	<b>139</b>
3 Arm	
Fundamentals _____	<b>147</b>
12" Towel Bars	
Fundamentals _____	<b>147</b>
15" Towel Bars	
Fundamentals _____	<b>147</b>
16" Towel Bars	
Arc Deco _____	<b>128-129</b>
Dual Harmony _____	<b>126-127</b>
Slip Stream _____	<b>130-131</b>
18" Towel Bars	
1948 Round _____	<b>132</b>
1948 Square _____	<b>133</b>
Allusion _____	<b>137</b>
Arctic Fox _____	<b>144</b>
Astral _____	<b>138</b>
Bitter Suite _____	<b>135</b>
Columbia _____	<b>147</b>
Electra _____	<b>136</b>
Fundamentals _____	<b>147</b>
Infinity _____	<b>146</b>
Lund _____	<b>140</b>
Naples _____	<b>141</b>
Northern Lights _____	<b>145</b>
Orion _____	<b>143</b>
Qube _____	<b>140</b>
Spellbound _____	<b>142</b>
Sunglow _____	<b>148</b>
Suite and Simple® _____	<b>134</b>
Wave _____	<b>139</b>
Yates _____	<b>146</b>
22" Towel Bars	
Dual Harmony _____	<b>126-127</b>
24" Towel Bars	
1948 Round _____	<b>132</b>
1948 Square _____	<b>133</b>
Allusion _____	<b>137</b>
Arc Deco _____	<b>128-129</b>
Arctic Fox _____	<b>144</b>
Astral _____	<b>138</b>
Bitter Suite _____	<b>135</b>
Columbia _____	<b>147</b>
Electra _____	<b>136</b>
Fundamentals _____	<b>147</b>
Infinity _____	<b>146</b>
Lund _____	<b>140</b>
Naples _____	<b>141</b>
Northern Lights _____	<b>145</b>
Orion _____	<b>143</b>
Qube _____	<b>140</b>
Slip Stream _____	<b>130-131</b>
Spellbound _____	<b>142</b>
Sunglow _____	<b>148</b>
Suite and Simple® _____	<b>134</b>
Wave _____	<b>139</b>
Yates _____	<b>146</b>

**TOWEL BARS CONTINUED**

24" Double Towel Bars	
Astral _____	<b>138</b>
Fundamentals _____	<b>147</b>
Orion _____	<b>143</b>
30" Towel Bars	
1948 Square _____	<b>133</b>
Astral _____	<b>138</b>
Infinity _____	<b>146</b>
Spellbound _____	<b>142</b>
Sunglow _____	<b>148</b>

**TOWEL RINGS**

1948 Round _____	<b>132</b>
1948 Square _____	<b>133</b>
Arctic Fox _____	<b>144</b>
Astral _____	<b>138</b>
Bitter Suite _____	<b>135</b>
Columbia _____	<b>147</b>
Electra _____	<b>136</b>
Fundamentals _____	<b>147</b>
Infinity _____	<b>146</b>
Lund _____	<b>140</b>
Naples _____	<b>141</b>
Northern Lights _____	<b>145</b>
Orion _____	<b>143</b>
Qube _____	<b>140</b>
Sunglow _____	<b>148</b>
Suite and Simple® _____	<b>134</b>
Yates _____	<b>146</b>
Double Towel Rings	
Bitter Suite _____	<b>135</b>
Suite and Simple® _____	<b>134</b>

**TOWEL SHELVES \_\_\_\_\_ 151**



@TAYMORDESIGN

*Since 1948*

*Vancouver, Toronto, San Francisco*

© TAYMOR® INDUSTRIES LTD.

08/23 • 99-CAT, PRINTED IN CANADA

**Taymor**®

**taymor.com**